

 **ROBERTS**[®]

20
24

**FLOORING TOOLS
& UNDERLAYMENT**

ROBERTS® KEY MILESTONES

- 1938:** Company founded
- 1938:** Introduced Smoothedge Carpet Gripper
- 1939:** Introduced Rub-er-er-ge Latex Carpet Adhesive
- 1949:** Filed Carpet Stretching Device patent
(*Today's kicker*)
- 1959:** Filed trademark for Anchor-Weld
- 1963:** Incorporated
- 1968:** Filed Loop Pile Carpet Cutter patent
- 1968:** Filed Cushion Back Carpet Cutter patent
- 1968:** Filed patent for Carpet Trimmer
(*Today's Wall Trimmer*)
- 1975:** Filed Carpet Adhesive Seaming Iron patent
(*Today's Deluxe Heat Bond Iron*)
- 1981:** Hot-Melt Carpet Seaming Tape was introduced and marketed worldwide
- 1987:** Became one of the first to market with solvent-free adhesives
- 1988:** Filed Carpet Stretcher patent
(*Today's Power-Lok® and Junior Power Stretcher*)
- 1994:** Filed Heat Seaming Iron patent (*Today's Cool Shield Heat-Bond Seaming Iron*)
- 1997:** QEP Co., Inc. acquired Roberts Consolidated Industries, Inc.
- 1998:** Filed Jamb Saw patent
- 2001:** Filed Carpet Knife patent
(*Today's Cut & Jam Knife*)
- 2005:** Launched AirGuard® Premium Underlayment
- 2017:** Filed Flooring Spacer patent
(*Today's Dual Expansion Flooring Spacer*)
- 2019:** Launched Universal+ Adhesives with Advanced Moisture Technology
- 2021:** Filed 4-in-1 Flooring Expansion Spacer patent
- 2023:** Filed patents on 7 new flooring tools
- 2024:** Introduced partnership with Microban® as exclusive North American adhesive provider of superior mold and mildew protection



The quintessential American dream, ROBERTS® began with a shared vision - a vision for working smarter not harder - to more quickly and efficiently install wall-to-wall carpet. Pooling a modest sum of \$3,000 to invest in plywood, a table saw, shingle nails, pliers and a few other essentials, Roy Roberts, Hugh Livie and Ken Bishop travelled the countryside selling and training installers to use tackless carpet strips.

Decades later, with countless patents and hundreds of products available worldwide, ROBERTS continues to be recognized as the world's authority on flooring installation tools, earning the respect and trust of generations of carpet installers.

We take great pride in the quality and dependability of our ROBERTS products and are committed to the evolution of these offerings to meet the needs and challenges of today's professional installers.

A Brand You Can Trust.

An iconic brand with an established market in more than 100 countries, ROBERTS capitalizes on decades of experience in the industry, fosters True Partnerships with national trade affiliates, and is committed to exceeding your expectations – one product at a time.

- **Award-winning, multilingual Customer Service Team**
- **Expert-level technical support to receive and resolve your product and industry questions**
- **Research & Development Team dedicated to improving, advancing, enhancing, and innovating our products through best of class findings from across the globe**
- **Partnership with industry affiliates including the International Certified Flooring Installers Association, the National Wood Flooring Association, and the Wood Floor Covering Association among others, to support and invest in the trade**
- **500K ft² of warehouse and manufacturing space to ensure job-lot quantities and availability of replacement parts**

ROBERTS® On-Going Commitment to Sustainability

We routinely challenge ourselves to reimagine the design, packaging and construction of our products with materials that are recycled, biodegradable or otherwise earth friendly. Our most recent eco-friendly / sustainability efforts include the following:

- **Removed single-use plastic from more than 200 items**
- **Replaced tens of thousands of lbs of virgin plastic with recycled plastic**
- **Eliminated 80,000+ lbs of plastic from our packaging**

Supporting Professional Installers
- Since 1938 -

THE ROBERTS CO.

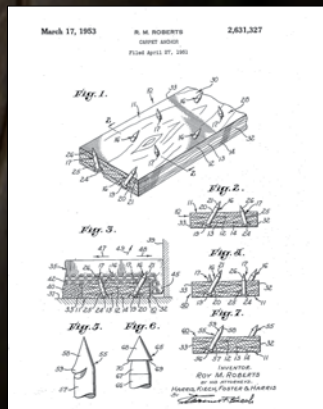
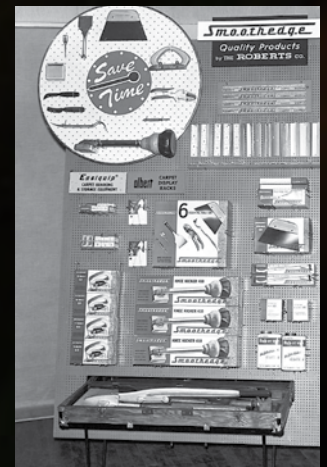
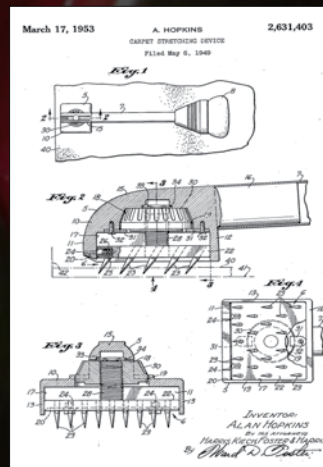
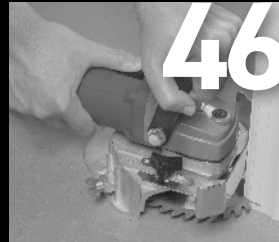

TABLE OF CONTENTS



6

CARPET TOOLS
CARPET STRETCHERS, HEAT-BOND IRONS, KNEE KICKERS, ROLLERS & HAND TOOLS



46

UNIVERSAL TOOLS
STAPLER, DOLLIES, GLIDER, SCRAPER, PRY BAR, HAMMER & HAND TOOLS

CUTTING TOOLS
CARPET CUTTERS, TRIMMERS, SHEARS, KNIVES & JAMB SAW



20



TROWELS
CARPET, VINYL & WOOD

52



29

TACK STRIP
TACK STRIP, CUTTERS, NAILS & NAIL DRIVING BAR



56

UNDERLAYMENT
LAMINATE, WOOD, LVT, VINYL & CORK



64

SPECIALTY TAPES
INSTALLATION, RUG GRIPPER & STAY 'N' PLACE TABS



32

VINYL TOOLS
VINYL CUTTERS, ROLLERS & HAND TOOLS



36

WOOD & LAMINATE TOOLS
FLOOR CUTTERS, INSTALLATION KITS, PUTTY, NAILS & HAND TOOLS

MERCHANDISING
GONDOLA, DUMP DISPLAYS, GRAVITY-FED-RACKS & COUNTERTOP DISPLAYS



68



CARPET TOOLS

Developed with the professional installer in mind, our carpet tools are the culmination of 86 years of precision, performance and patents. From our Power-Lok® and Locking Pattern Matching Seam Repair Stretchers to The General™ Knee Kicker, Cool Shield® Heat Bond Seaming Iron, and everything in between, you can expect quality and satisfaction from all of our carpet tools.

POWER-LOK[®] STRETCHER

The Power-Lok[®] Stretcher is the most advanced power stretcher available.



10-254V



- Swivel head locks into 17 different stretch / pattern-holding positions
- Adjustable pin penetration for different carpet thicknesses
- Non-marring tail block prevents damage to finished walls while stretching
- Low-profile head with side-kicking platform for use with knee kicker
- Stretch up to 38' (with the value kit) and up to 23½' (with the standard kit)

The Power-Lok[®] Stretcher standard kit includes a power unit, tail block with wheels, three 3' extension tubes, adjustable locking tube, transfer tube and the wheeled-stretcher carrying case. The Power-Lok[®] Stretcher value kit includes everything in the standard kit PLUS three additional 3' tubes, and the tube carrying case which interlocks with the wheeled stretcher case.

Item No.	Description	Case Qty	Packaging
10-254	Power-Lok [®] Carpet Stretcher Standard Kit	1	Carrying Case
10-254V	Power-Lok [®] Carpet Stretcher Value Kit	1	Carrying Case
10-254-50	Replacement: Stretcher Head	1	Carton
10-248	Accessory: Nap Grip Head	1	Carton

JUNIOR POWER CARPET STRETCHER



The Junior Power Carpet Stretcher is our most economical power stretcher and ideal for professional installers.



10-237V

- Locking handle ensures proper stretch
- Low-profile power head is easy to span with a knee kicker
- 18" spring-loaded tail block with wheels provides additional support
- Stretches over 38' (with the value kit) and up to 23½' (with the standard kit)

The Junior Power Stretcher standard kit includes a power unit, tail block with wheels, three 3' extension tubes, adjustable locking tube, transfer tube and wheeled-stretcher carrying case. The Junior Power Carpet Stretcher value kit includes everything in the standard kit PLUS three additional 3' tubes, and the tube carrying case which interlocks with the wheeled stretcher case.

Item No.	Description	Case Qty	Packaging
10-237	Junior Power Carpet Stretcher Standard Kit	1	Carrying Case
10-237V	Junior Power Carpet Stretcher Value Kit	1	Carrying Case
10-237-50	Replacement: Stretcher Head	1	Carton
10-248	Accessory: Nap Grip Head	1	Carton



ADDITIONAL STRETCHER TUBES



Engineered for superior performance and durability, and designed to fit all ROBERTS® and standard stretchers.

Item No.	Description	Case Qty	Packaging
10-250	Adjustable Locking Tube	1	Carton
10-230-10	3' Steel Stretcher Tube (for use with 10-254, 10-254V, 10-237 and 10-237V stretchers)	1	Carton
10-235-10	3' Aluminum Stretcher Tube (not shown)	1	Carton
10-235-05	5' Aluminum Stretcher Tube (not shown)	1	Carton

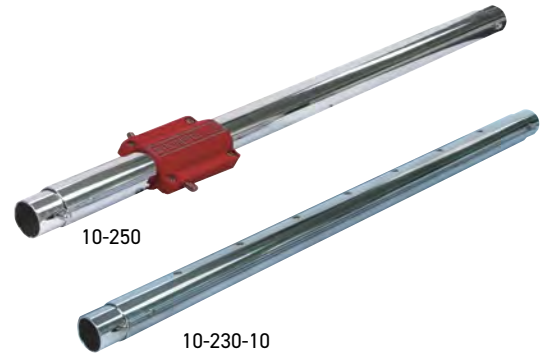

STRETCHER CASE SYSTEM

ROBERTS® Stretcher Case System includes a stretcher case with wheels, and a tube case that interlocks to the stretcher case for easy transport.

- Comfort-grip handle and 4" wheels for easier transport
- Recessed hinges and latches to prevent breakage
- High-density, blow-molded plastic walls for added durability
- Nylon web belt with quick-release buckle to secure the cases together

The stretcher case can accommodate ROBERTS® Power-Lok® or Junior Power stretcher unit, tail block with wheels, three 3' extension tubes, adjustable locking tube and transfer tube.



Item No.	Description	Case Qty	Packaging
10-230-40	Empty Stretcher Case with Wheels (for use with 10-254, 10-254V, 10-237 and 10-237 V stretchers)	1	Carton
10-230-3K	Tube Case with Three 3' Extension Tubes	1	Carton

NAP GRIP HEAD (COTTON HEAD)

Designed for use on low-profile loop, cut pile and woven carpets, Nap Grip Head. It is compatible with both the Power-Lok® and Junior Power Carpet Stretchers.

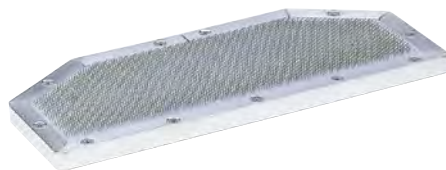

Item No.	Description	Case Qty	Packaging
10-248	Nap Grip Head (for use with 10-254, 10-254V, 10-237 and 10-237V)	1	Carton

POWER STRETCHER TAIL

Designed to fit ROBERTS® stretchers, the Power Stretcher Tail pierces through carpet and pad into wood for a firm, solid stretch, even when there are no walls to brace against.



Item No.	Description	Case Qty	Packaging
10-258	Power Stretcher Tail (for use with 10-254, 10-254V, 10-237 and 10-237V)	1	Carton

LOCKING PATTERN MATCHING & SEAM REPAIR STRETCHER

Designed to quickly and accurately match patterns during carpet installation and repair.



- ON/OFF locking mechanism locks the powerhead at 1/4" movement of the pinplate, ensuring precise pattern alignment
- Dual powerhead configuration for correcting bowing, skewing, and misaligned patterns, as well as compressing gapped seams
- Adjustable pin depths to accommodate different carpet thicknesses
- Die-cast frame holds up to 300 lbs. of stretch tension
- Includes custom-molded carrying case



Item No.	Description	Case Qty	Packaging
10-128	Locking Pattern Matching & Seam Repair Stretcher	1	Carrying Case
10-117-04	Replacement: Power Head Unit	1	Carton
10-107-03	Replacement: Tail Blade Unit	1	Carton

WARNING: Cancer and Reproductive Harm - www.P65Warnings.ca.gov. See P. 75, *Prop 65 - 1.

The GENERAL™ KNEE KICKER



The General™ features an extra-wide 5" head, four nap grip strips and five rows of steel pins to maneuver carpet with ease and precision.

- 25% wider head for improved load distribution
- Gel bumper is mounted at a 5° angle to maximize kicks while reducing knee shock
- High-contour neck for use over stretcher head and poles
- Easy adjustments from 17½" to 21½"
- Center grooved head for adjusting power stretcher head
- Die-cast aluminum body for maximum strength and durability

Item No.	Description	Case Qty	Packaging
10-2100	The General™ Knee Kicker	3	Printed Carton



5 ROWS OF
STEEL PINS & **4** NAP GRIPS
**ENSURE
MAXIMUM
GRIP**



17½" - 21½"



GOLDEN TOUCH® CARPET KNEE KICKER

The Golden Touch® Carpet Knee Kicker provides the greatest length adjustment for repairing and/or stretching loose carpet.

- Trigger release adjusts from 18-7/8" to 24"
- High-contour neck for use over stretcher head and poles
- Center grooved head for adjusting power stretcher head
- Easy-to-read, easy-to-adjust pin depth dial



Scan Here FOR PRODUCT INFO



Item No.	Description	Case Qty	Packaging
10-501	Golden Touch® Carpet Knee Kicker	3	Printed Carton
10-412-09	Replacement: Bumper Pad (2" thick)	1	Carton
10-422-09	Replacement: Bumper Pad (3" thick)	1	Carton

DELUXE HIGH-PROFILE KNEE KICKER

Featuring installer-designed enhancements, the Deluxe High-Profile Knee Kicker is engineered with a solid construction and durability.

- Trigger release adjusts from 18½" to 22½"
- High-contour neck for use over stretcher head and poles
- 50% thicker bumper pad for extra knee comfort
- 16% wider head for improved load distribution
- Non-slip, checkered hand grip
- Center grooved head for adjusting power stretcher head



Scan Here FOR PRODUCT INFO



Item No.	Description	Case Qty	Packaging
10-422BK	Deluxe High-Profile Knee Kicker	3	Printed Carton
10-412-09	Replacement: Bumper Pad (2" thick)	1	Carton
10-422-09	Replacement: Bumper Pad (3" thick)	1	Carton

DELUXE KNEE KICKER

Elevating the industry standard in knee kickers, the Deluxe Carpet Knee Kicker has been in use for over 40 years.

- Trigger release easily adjusts from 17" to 21"
- Non-slip, checkered hand grip
- Foam-filled seamless bumper pad for extra comfort
- Center grooved head for adjusting power stretcher head
- Easy-to-read, easy-to-adjust pin depth dial



Scan Here FOR PRODUCT INFO



Item No.	Description	Case Qty	Packaging
10-412-2	Deluxe Knee Kicker Silver (no case)	2	Printed Carton
10-412BKK	Deluxe Knee Kicker Black (with case)	3	Printed Wrap
10-412-09	Replacement: Bumper Pad (2" thick)	1	Carton
10-422-09	Replacement: Bumper Pad (3" thick)	1	Carton

⚠️WARNING: Cancer and Reproductive Harm - www.P65Warnings.ca.gov. See P. 75, *Prop 65 - 2.

ADJUSTABLE KNEE KICKER



The Adjustable Carpet Knee Kicker is ideal for your basic carpet installation.

- Double locking pins easily adjust length from 19" to 23"
- High-contour neck for use over stretcher head and poles
- Center grooved head for adjusting power stretcher head
- Easy-to-read, easy-to-adjust pin depth dial



Scan Here
FOR PRODUCT INFO



Item No.	Description	Case Qty	Packaging
10-410	Adjustable Knee Kicker	3	Printed Carton
10-412-09	Replacement: Bumper Pad (2" thick)	1	Carton
10-422-09	Replacement: Bumper Pad (3" thick)	1	Carton

BUMPER PADS

Designed for use with adjustable knee kickers, the foam replacement bumper pads are compatible with The General™, Knee Kicker, Golden Touch® Knee Kicker, Deluxe Knee Kicker, Deluxe High-Profile Knee Kicker and Adjustable Knee Kicker. Available in 2" or 3" thick sizes.



Item No.	Description	Case Qty	Packaging
10-412-09	Replacement: Bumper Pad (2" thick)	1	Carton
10-422-09	Replacement: Bumper Pad (3" thick)	1	Carton

LOOSE CARPET A PROBLEM?

Put it in its place with our *Economy Knee Kicker!*

ECONOMY KNEE KICKER

- ✓ Lightweight
- ✓ Easy to use
- ✓ Great for hallways & closets



Item #10408

Scan Here
FOR PRODUCT INFO



COOL SHIELD® HEAT BOND IRON



Designed to seam carpets like a professional, the Cool Shield® Heat Bond Iron melts 3" heat bond tapes while shielding carpets against heat damage.

- Double heat shield minimizes deforming of carpet backing and face yarn
- S-shaped heating element provides even heating and longer heat retention
- Comb profile forms ridges in adhesive for stronger carpet seams
- Top mounted thermostat control for easy heat-setting adjustments
- 3-way cord guide keeps the 9½' cord out of the way
- Grooved non-stick plate for fast, easy clean-up
- Thermostat indicator light shows when iron is heating
- Approximate heat range 135°F to 428°F



Scan Here FOR PRODUCT INFO



Item No.	Description	Case Qty	Packaging
10-482G	Cool Shield® Heat Bond Iron (110V)	3	Printed Carton

DELUXE HEAT BOND IRON



The Deluxe Heat Bond Iron is the first choice of carpet installation professionals worldwide.

- Low-profile design makes seaming carpet easy with 3" heat-bond seaming tapes
- Even heat distribution for faster more efficient melting
- Up-front thermostat control for easy heat-setting adjustments
- Thermostat indicator light changes from red to green when desired temperatures is achieved
- Heat shield prevents backings from overheating
- Comb profile forms ridges in adhesive for stronger carpet seams
- 2-way pivoting cord for easier control
- Non-stick coated plate for easy clean-up
- Approximate heat range 135°F to 425°F



Scan Here FOR PRODUCT INFO



Item No.	Description	Case Qty	Packaging
10-282G-2	Deluxe Heat Bond Iron (110V)	2	Printed Carton

6" HEAT BOND SEAMING IRON



The extra-wide 6" Heat Bond Seaming Iron is ideal for use with wider carpet seam tapes.

- Custom designed to distribute heat evenly from front to tail
- Grooved non-stick plate for fast, easy clean-up
- Up-front thermostat control for easy heat-setting adjustments
- Tapered base plate design joins carpet at back of iron
- 3-way cord guide keeps cord out of the way
- Approximate heat range 135°F to 425°F



Scan Here FOR PRODUCT INFO



Item No.	Description	Case Qty	Packaging
10-286G	6" Heat Bond Seaming Iron (110V)	3	Printed Carton

PROFESSIONAL ELECTRIC STAPLER



Powerful and reliable, the Professional Electric Stapler will meet the needs of the most demanding carpet installation.

- 6 $\frac{3}{4}$ " low-profile head allows easy access in tight places, particularly stairs
- 120-v, 15 amp solenoid delivers more power to drive staples deeper
- Quick-release, bottom-loading magazine for fast reloading (85 staple capacity)
- Hardened driver mechanism shoots 20 gauge, 9/16" crown staples
- Heavy 14 gauge, 12' power cord offers maximum power and mobility
- Compatible with most standard 9/16" divergent point staples



Scan Here
FOR PRODUCT INFO



Item No.	Description	Case Qty	Packaging
10-600	Professional Electric Stapler (with carrying case)	1	Printed Carton
10-5418D	9/16" Staples (5000/box)	20	Printed Carton

STAPLE HAMMER

The Staple Hammer is ideal for installing carpet padding, roofing felt, insulations, canvas framing and upholstery.

- Designed for quick, repetitive stapling
- Steel construction for superior durability
- Quick and easy back-end loading, holds 160 staples for more shots per load
- Comfortable, non-slip grip for extended use
- Compatible with 3/8" divergent point or chisel point staples



Item No.	Description	Case Qty	Packaging
10-109	Staple Hammer	6	Printed Carton
30-110	3/8" Chisel Point Staples (5000/box)	20	Printed Carton
30-210	3/8" Divergent Point Staples (5000/box)	20	Printed Carton

CHISEL POINT STAPLES

V-shaped points of the Chisel Point Staples drive easily into most wood floors to prevent jamming.



Item No.	Description	Case Qty	Packaging
30-110	3/8" Chisel Point Staples (5000/box)	20	Printed Carton

DIVERGENT POINT STAPLES

Designed for use with vinyl tile, felt and wood (including hardwood), the Divergent Point Staples provide extra holding power.



Item No.	Description	Case Qty	Packaging
30-210	3/8" Divergent Point Staples (5000/box)	20	Printed Carton
10-5418D	9/16" Staples (5000/box)	20	Printed Carton

HEAVY-DUTY FLOORING ROLLERS

Ideal for pressing carpet into adhesive, the heavy-duty 100 and 75 lb. rollers are designed to evenly distribute and flatten adhesive build-up, ensuring a level installation.



- Segmented, chrome-plated rollers ensure even pressure into flooring
- Detachable transport wheels protect the precision balanced rollers
- Designed with inset axles to prevent wall scuffing
- Removable 30" handle for convenient storage

Item No.	Description	Case Qty	Packaging
10-950	75 lbs. Heavy-Duty Flooring Roller	1	Labeled Box
10-952	100 lbs. Heavy-Duty Flooring Roller	1	Labeled Box
10-935	35 lb. Vinyl & Linoleum Flooring Roller	1	Box
10-952-04	Replacement: Transport Wheel Assembly Kit	1	Carton

Scan Here FOR PRODUCT INFO



10-950

⚠WARNING: Cancer and Reproductive Harm - www.P65Warnings.ca.gov. See P. 75. *Prop 65 - 1.

* For 35 lb. vinyl roller, see page 34.

6" PRO CUT PILE CARPET SEAM ROLLER



Featuring smooth wheels and is designed for use with cut pile carpets, saxonies and vinyl seams.

- 6" head is optimally sized to work with most seam tapes
- Extended, angled handle provides optimal leverage
- Recessed hardware prevents damage or marking to walls
- Smooth wheels force carpet backing into seam tape



Item No.	Description	Case Qty	Packaging
10-124	6" Pro Cut Pile Carpet Seam Roller	3	Peg Card

6" PRO LOOP PILE CARPET SEAM ROLLER



Featuring star wheels for stronger seams, the 6" PRO Loop Pile Carpet Seam Roller is designed for use with loop pile and Berber carpets as well as securing carpet on tack strip.

- 6" head is optimally sized to work with most seam tapes
- Extended, angled handle provides optimal leverage
- Recessed hardware prevents damage or marking to walls
- Star wheels maximize hot-melt transfer into carpet back for stronger seams



Item No.	Description	Case Qty	Packaging
10-122	6" Pro Loop Pile Carpet Seam Roller	3	Peg Card

4" CUT PILE SEAM ROLLER



Featuring smooth wheels to force carpet backing into seaming tape, the 4" Cut Pile Seam Roller is designed for use with cut pile carpets, saxonies and vinyl seams.

- Smooth roller forces carpet backing into seam tape without fraying yarn ends
- Extended, angled soft-grip handle for better leverage



Item No.	Description	Case Qty	Packaging
10-170	4" Cut Pile Seam Roller	3	Peg Card

4" STAR WHEEL PRO CARPET SEAM ROLLER



4" Star Wheel Pro Carpet Seam Roller is designed for use with loop pile and Berber carpets as well as securing carpet on tack strips.

- Star wheels maximize hot-melt transfer into carpet back for stronger seams
- Extended, angled soft-grip handle for better leverage



Item No.	Description	Case Qty	Packaging
10-169	4" Star Wheel Pro Carpet Seam Roller	3	Peg Card

5" CARPET SEAM ROLLER

Specifically designed for loop pile carpet, the 5" Carpet Seam Roller brings carpet pile together.

- Extra-wide 5" head reduces dishing in seam area and improves pile transition
- Star wheels maximize hot-melt transfer into carpet back for stronger seams
- Durable, lightweight die-case handle



Item No.	Description	Case Qty	Packaging
10-100	5" Carpet Seam Roller	3	Peg Card

4.5" DELUXE CARPET SEAM ROLLER

Lightweight design and comfortable, non-slip handle make the 4.5" Deluxe Carpet Seam Roller ideal for use when seaming loop pile carpets.

- 3 rows of rollers to maximize adhesive absorption
- Extra-wide 4.5" head reduces dishing
- Lightweight design minimizes user fatigue
- Wide, nonslip handle makes the roller easy to use



Item No.	Description	Case Qty	Packaging
10-101	4.5" Deluxe Carpet Seam Roller	4	Peg Card

24" STEEL TOOL BOX



The 24" Steel Tool Box is designed with the pro installer in mind—rugged, spacious and multi-functional.

- Inset side handles safeguard durability during transport
- Dual-purpose storage tray serves as a seaming weight
- Heavy-duty steel construction for dependable, multifunctional use and toughness
- Full-length piano-style hinge for easy access
- Two heavy-duty fastening hasps, and locking loops for security
- 24" W x 9.75" H x 8.75" D, with plenty of space for a variety of installation tools



Scan Here FOR PRODUCT INFO



Item No.	Description	Case Qty	Packaging
10-163	24" Steel Tool Box	1	Printed Carton

⚠️WARNING: Cancer and Reproductive Harm - www.P65Warnings.ca.gov
See P. 75. *Prop 65 - 1.

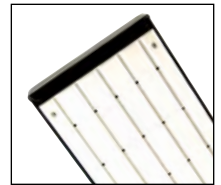

Storage tray with nylon plates acts as a seaming weight

DELUXE CARPET INSTALLATION KIT



Key to an installer's success, the Deluxe Carpet Installation Kit features one each of the following:

Item No.	Description
10-163	24" Steel Tool Box
10-169	Loop Pile Seam Roller
10-108	Professional 2" Strip Cutter
10-109	Staple Hammer
10-114	20-oz Ripping Hammer
10-146GT	Golden Touch Cushion Back Cutter
10-151	Nail Driving Bar
10-152GT	Golden Touch Loop Pile Cutter
10-616-2A	Conventional Carpet Trimmer
10-252	Professional Carpet Knife
10-260	Deluxe Grip Tool Pouch
10-303S	Chalk Reel
10-321	White Chalk Refill (8 oz)
10-412-2	Deluxe Knee Kicker
10-503	Pro Mini Pry Bar
10-521	Pro Stair Tool
10-522-4	EZ Tuk Carpet Tucker
10-586-3	7" Duckbill Napping Shears
10-920-6	Pro Fixed Blade Utility Knife
10-931	Vinyl Flooring Knife
10-140	30' Tape Measure
10-517	Row Finder & Separator
61613	White Rubber Mallet



KIT VALUE SAVINGS \$175

Item No.	Description	Case Qty	Packaging
10-750	Deluxe Carpet Installation Kit	1	Printed Carton

Scan Here FOR PRODUCT INFO



NOTE: Contents may vary depending on inventory available.

⚠️WARNING: Cancer and Reproductive Harm - www.P65Warnings.ca.gov. See P. 75. *Prop 65 - 1.

CARPET RAKE & GROOMER

The Carpet Rake & Groomer loosens and lifts embedded soil and hair from carpet. Ideal for quick and easy maintenance of cut pile carpet.

- Specially designed bristles reach deep into the base of carpet to loosen debris
- Extra-long 51" handle and 12" wide head grooms large areas quickly
- Three-part handle can be disassembled for quick, easy storage

Item No.	Description	Case Qty	Packaging
70-127-3	Carpet Rake & Groomer	3	Printed carton

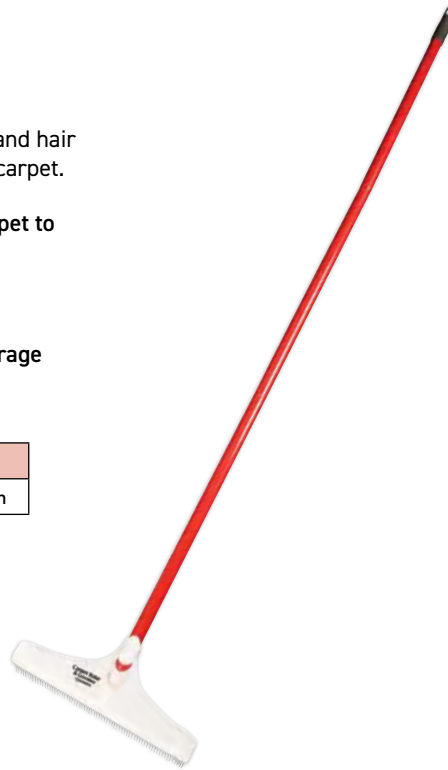

PRO STAIR TOOL



Made from forged, chrome-plated steel for long-lasting strength and durability, the Pro Stair Tool is ideal for setting carpet into tack strip, driving carpet into gullies and creasing carpet along wall line.

- Heavy-duty 4" blade easily sets carpet into stairway crevices
- Chrome-plate steel design for added durability

Item No.	Description	Case Qty	Packaging
10-521	Pro Stair Tool	3	Peg Card



ROW FINDER & SEPARATOR

The Row Finder & Separator is ideal for separating carpet rows to minimize damage to nap and loops.

- Features tapered round end for cut pile carpets and flattened end for loop pile carpets
- Slip-resistant, checkered grip
- Steel construction for durability



Item No.	Description	Case Qty	Packaging
10-517	Row Finder & Separator	6	Peg Card

EZ TUK CARPET TUCKER

A lightweight tucking tool, the EZ TUK Carpet Tucker will not mark or damage baseboards, walls, ceramic tiles or metal.

- Ball handle for a secure hold
- Curved edge is ideal for stairs
- Square edge works well for tucking carpet into corners
- 3½" wide blade for faster tucking



made in
USA

Item No.	Description	Case Qty	Packaging
10-522-4	EZ TUK Carpet Tucker	4	Peg Card



CUTTING TOOLS

Whether the goal is cutting, trimming, slicing or scoring, you can expect precision, innovation and versatility with each of our products. Designed by pros for pros, we've taken every facet of cutting into account - from knife construction and blade angle to handle grip and blade storage, and everything in between.

CONVENTIONAL CARPET TRIMMERS



Designed to quickly trim carpet along the wall or under toe kicks, Carpet Trimmers are an installer's must have carpet tool.

- 5-position folding handle moves easily in hard-to-reach areas
- Accommodates vertical and horizontal adjustments
- Anti-slip rubber handle and hardened stainless steel guide for accurate cuts

Item No.	Description	Case Qty	Packaging
10-616-2A	Conventional Carpet Trimmer Includes: 20 Heavy-duty Trimmer Blades	2	Peg Clamshell
10-617GT	Golden Touch® Carpet Trimmer Includes: Dual layer spring steel blade clips	2	Blister Card



10-616-2A



10-617GT

MULTIPURPOSE WALL TRIMMER



Ideal for cutting carpet, soft vinyl sheet goods, carpet tiles and cushion back for glue-down carpet, the stainless steel constructed Multipurpose Wall Trimmer makes clean cuts without marking walls.

- Fully adjustable for most material thicknesses
- Snap-on, anti-friction boot glides smoothly over sheet goods
- Hooked blades can be used to cut carpet tiles quickly and easily
- Slotted blades can be used for regular carpet or vinyl sheet goods

Item No.	Description	Case Qty	Packaging
10-905	Multipurpose Wall Trimmer	3	Peg Card



LOOP PILE CUTTERS



Developed for cutting loop pile carpets, the Loop Pile Cutter is stainless steel constructed for maximum durability.

- Throat opening adjusts automatically for different carpet backs
- Unique two-blade design accommodates both left and right hand cutting
- Direct-contact locking design keeps blades securely in place
- Ergonomic grip for comfort and control

Item No.	Description	Case Qty	Packaging
10-152-3	Loop Pile Cutter Includes: 15 Heavy-duty slotted blades	3	Half Clamshell
10-152GT	Golden Touch® Loop Pile Cutter	6	Peg Card



10-152-3



10-152GT

CUSHION BACK CARPET CUTTERS



Made of stainless steel for maximum durability, the Cushion Back Carpet Cutter is ideal to cut cushion back and conventional carpet.

- Direct-pressure blade knob holds blades tightly in place
- Adjustable blade depth for all carpet thicknesses
- Two blades lock into position for close, precise cutting

Item No.	Description	Case Qty	Packaging
10-146-3	Cushion Back Carpet Cutter Includes: 15 Heavy-duty slotted blades	3	Half Clamshell
10-146GT	Golden Touch Cushion Back Carpet Cutter	6	Peg Card



10-146-3



10-146GT

UNIVERSAL SEAM CUTTER



The Universal Seam Cutter is designed for top and bottom carpet cutting.

- Superior dual design. Use slotted blade for top cutting or utility blade for bottom cutting
- Extra-long nose provides better row separation
- 50° blade angle permits cleaner precise cuts
- Quick-release blade replacement for fast blade changes

Item No.	Description	Case Qty	Packaging
10-154-3	Universal Seam Cutter	3	Peg Card



10" CARPET SHEARS

Featuring precision ground, high-quality carbon steel blades for maximum durability, the 10" Carpet Shears are ideal for use in-between areas like staircases and upholstery.

- Superior cutting ability and durability
- Accommodate large hands comfortably with vinyl-coated cushioned handle openings
- Blade edge sharpens easily on stone
- Chrome plated blades

Item No.	Description	Case Qty	Packaging
10-123	10" Carpet Shears	6	Polybag

made in USA



⚠WARNING: Cancer - www.P65Warnings.ca.gov. See P. 75, *Prop 75 - 3.

8" NAPPING SHEARS

Manufactured with ground blades to ensure precision cuts, the 8" Napping Shears are the go-to tool for easy and level napping of carpet fibers.

- Offset-handles ensure level napping
- Accommodate large hands comfortably with extra wide, vinyl-coated cushioned handle openings
- The blades are precision ground to ensure sharp cutting edges
- Chrome plated with knife edges

Item No.	Description	Case Qty	Packaging
10-121	8" Napping Shears	6	Polybag

made in USA



Side angle profile

⚠WARNING: Cancer and Reproductive Harm - www.P65Warnings.ca.gov. See P. 75, *Prop 65 - 1.

DUCKBILL NAPPING SHEARS



Designed for maximum durability, the Duckbill Napping Shears are the perfect tool for quick, easy and exact carpet trimming.

- Offset-handle design for easy blade positioning and level napping
- Accommodates large hands comfortably with extra wide, vinyl-coated cushioned handle openings
- The blades are precision ground to ensure sharp cutting edges
- Chrome plated with knife edges

Item No.	Description	Case Qty	Packaging
10-585	6" Duckbill Napping Shears	6	Peg Card
10-586-3	7" Duckbill Napping Shears	3	Peg Card

made in USA

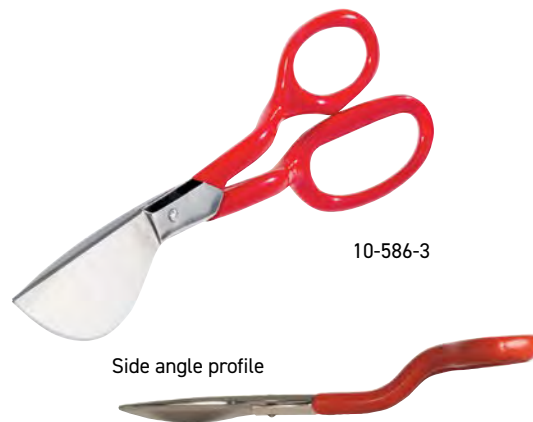

10-586-3

Side angle profile

⚠WARNING: Cancer - www.P65Warnings.ca.gov. See P. 75, *Prop 65 - 3.

3-IN-1 CARPET, VINYL & UTILITY KNIFE



The 3-In-1 Carpet, Vinyl & Utility Knife is considered the premier knife among installers, largely due to its versatility. With a quick blade change, it can be used to install carpet, LVT/LVP - or as a utility knife to cut twine and cardboard.

- Patented insert with 3 positions according to blade type and cutting use
- NEW SWIVEL GRIP™ blade storage accommodates 20 individual blades or most 10-pack cartridges
- 45-degree angle is optimal for scoring and breaking rigid materials
- Can be used with carpet or utility blades according to need
- Ergonomic design and molded comfort grip for all day use

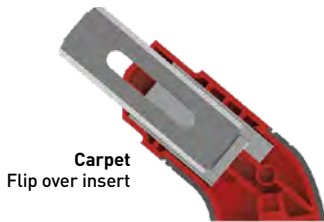

Item No.	Description	Case Qty	Packaging
10-216	3-in-1 Carpet, Vinyl & Utility Knife	6	Peg Card

Accommodates 20 individual blades or most 10-pack cartridges

PRO DUAL-DEPTH CARPET KNIFE



The Pro Dual-Depth Carpet Knife provides tool-free, easily adjustable blade depth options: 9/16" or 13/16" to accommodate different carpet back thickness.

- Patented insert provides tool-free, easily adjustable blade-depth options: 9/16" or 13/16" to accommodate different carpet thicknesses
- NEW SWIVEL GRIP™ blade storage accommodates 20 individual blades or most 10-pack cartridges
- Wider thumb stop for improved leverage, comfort and control
- Ergonomic design to better fit in hand



Item No.	Description	Case Qty	Packaging
10-259	PRO Dual-Depth Carpet Knife	6	Peg Card

Accommodates 20 individual blades or most 10-pack cartridges

PROFESSIONAL CARPET KNIFE



The Professional Carpet Knife is the go-to knife for professional installers.

- Special thumb-stop design provides safety and increased cutting pressure
- Easy push button for quick blade changing
- Knurled, slip-resistant grip assures firm grip
- Convenient built-in blade storage inside the handle



Item No.	Description	Case Qty	Packaging
10-252	Professional Carpet Knife (includes 3 blades)	6	Peg Card

CUT & JAM CARPET KNIFE



Uniquely designed to serve a dual function, the Cut & Jam Carpet Knife cuts carpet with one end and tucks carpet into gullies with the other.

- Features an easy-open knob with bail, safety thumb and blade guards
- Checkered handle for a slip resistant grip
- Rugged, lightweight precision die cast aluminum
- Handle stores up to 10 additional heavy-duty slotted blades



Item No.	Description	Case Qty	Packaging
10-220	Cut & Jam Carpet Knife (includes 3 blades)	6	Peg Card

RAZOR BLADE KNIFE



Featuring die-cast aluminum construction for lightweight durability, the Razor Blade Knife quickly and efficiently cuts carpet during installation.

- Features safety guards to keep blade firmly in place
- Checkered handle for a slip resistant grip
- Rugged, lightweight precision die cast aluminum
- Handle stores additional slotted blades



Item No.	Description	Case Qty	Packaging
10-215	Razor Blade Knife (includes 3 blades)	6	Peg Card

SLOTTED BLADE CARPET KNIFE



Easy to control and maneuver, and featuring a blade guard for added safety, the Slotted Blade Carpet Knife is the preferred choice of DIY installers.

- Contoured handle for precise cutting and firm grip
- Extra blade storage in the handle
- Large screw assembly offers easy blade changes



Item No.	Description	Case Qty	Packaging
10-253	Slotted Blade Carpet Knife (includes 2 blades)	12	Peg Card

⚠️WARNING: Cancer and Reproductive Harm - www.P65Warnings.ca.gov. See P. 75, *Prop 65 - 2.

BIG FATSO MULTIPURPOSE KNIFE



Ideal to mark, score or trim, the Big Fatso Multipurpose Knife is a great knife to have in your toolbox.

- Large contoured handle for comfort
- Offset head gives knuckle room and precise cutting angle
- Convenient on-board blade storage
- Accommodates both utility and hooked blades



Item No.	Description	Case Qty	Packaging
10-218F	Big Fatso Multipurpose Knife (includes 3 blades)	12	Peg Card
10-440	Replacement: Hooked Blades (1.84" long x .25" thick) 100 blades per 10-pk: 1000 Blades	10	Trapped Blister
10-404	5-Pack Hawk Utility Blades (2.3" long x .75" wide x .67 mm thick) 5 blades per card, 10 cards per case	10	Trapped Blister

PRO UTILITY KNIFE



Developed to achieve professional results, the Pro Utility Knife cuts carpet, vinyl, drywall and roofing materials.

- Magnetic tip helps secure the blade in place
- Contoured handle provides improved grip and knife control
- Thumb wheel for quick-blade change
- Convenient on-board blade storage
- Accommodates both utility and hook blades



Item No.	Description	Case Qty	Packaging
10-221	Pro Utility Knife (includes 3 blades)	6	Peg Card
10-440	Replacement: Hooked Blades (1.84" long x .25" thick) 100 blades per 10-pk: 100 Blades	10	Trapped Blister
10-404	5-Pack Hawk Utility Blades (2.3" long x .75" wide x .67 mm thick) 5 blades per card, 10 cards per case	10	Trapped Blister

PRO FIXED-BLADE UTILITY KNIFE



The Pro Fixed-Blade Utility Knife is perfect for marking, scoring, trimming and cutting a variety of materials.

- Checkered handle for a slip resistant grip
- Easy-open knob with bail for quick-blade change
- Convenient on-board blade storage
- Accommodates both heavy-duty utility and hooked blades



Item No.	Description	Case Qty	Packaging
10-920-6	Pro Fixed-Blade Knife (includes 3 blades)	6	Peg Card
10-440	Replacement: Hooked Blades (1.84" long x .25" thick) 100 blades per 10-pk: 100 Blades	10	Trapped Blister
10-404	5-Pack Hawk Utility Blades (2.3" long x .75" wide x .67 mm thick) 5 blades per card, 10 cards per case	10	Trapped Blister

PRO VINYL FLOORING KNIFE

High-quality, versatile knife cuts and tucks with ease and precision.

- Curved blade slices linoleum, vinyl sheet goods and carpet
- Tapered, flat-top surface for use as a carpet tucker
- Blade made from hardened stainless steel for extra durability
- Ergonomic grip for enhanced performance and comfort



Item No.	Description	Case Qty	Packaging
10-925	Pro Vinyl Flooring Knife	12	Peg Card

VINYL FLOORING KNIFE



Featuring a heavy-gauge, high carbon steel blade, the Vinyl Flooring Knife cuts linoleum, resilient and sheet vinyl, as well as vinyl composition tile (VCT).

- Makes accurate, even cuts without burrs or jagged edges
- Double-edge sharp blade for smooth, quick cuts



Item No.	Description	Case Qty	Packaging
10-931	Vinyl Flooring Knife	12	Half Clamshell

HOOKED BLADES

Precision sharpened for accurate cutting, Hooked Blades are ideal for use with carpet knives, trimmers and cutters.

- Heavy-duty, high-quality steel for professional results
- Hooked blade design features two positioning stops for added versatility



Item No.	Description	Case Qty	Packaging
10-440	Hooked Blades (1.84" long x .25" thick) 10 blades per card, 10 cards per case	10	Trapped Blister

made in
USA

HAWK UTILITY BLADES

Designed for cutting and scoring various materials including LVP, acrylic light panels, vinyl tile, rubber and flooring underlayment.

- Tough carbon steel blade offers dependable, everyday cutting and trimming
- Fits most standard utility knives



Item No.	Description	Case Qty	Packaging
10-404	5-Pack Hawk Utility Blades (2.3" long x .75" wide x .67 mm thick) 5 blades per card, 10 cards per case	10	Trapped Blister

STRIP CUTTER BLADES

Tack Strip Cutter Replacement Blades are manufactured to be used with Professional Strip Cutter.

- Blades are made of high carbon steel for hardness and durability
- 1.86" long x .45" wide x 0.38" thick



Item No.	Description	Case Qty	Packaging
10-439	6 Strip Cutter Blades Blister Cards (1.86" long x .45" wide x 0.38" thick) 6 blades per card, 10 cards per case	10	Trapped Blister

LONGNECK PLUS 6" JAMB SAW



Fitted with a powerful 1100-watt industrial-grade motor, the Longneck Plus 6" Jamb Saw cuts doors, jambs, trim and molding for installation of new floors, as well as brick and cement block.

- Patented design enables saw to cut full inside corners in molding up to 1/2" thick
- Extended "tail" for maximum leverage against torque
- Adjustable cutting depth guide prevents cutting into plaster or wall board when trimming base boards
- Precision height adjustment from "flush" to 1-1/16"
- 1 1/2" vacuum port for optimal dust containment
- 1100-watt, 120V ~ 60Hz, 9.6 AMPs motor cuts with ease
- Includes one 6-3/16" 36-Tooth Carbide-Tipped Saw Blade (10-47-2)



Scan Here
FOR PRODUCT INFO



Item No.	Description	Case Qty	Packaging
10-56	Longneck Plus 6" Jamb Saw (with carrying case)	1	Carrying Case
10-47-2	Replacement: 6-3/16" 36-Tooth Carbide-Tipped Saw Blade	2	Peggable Clamshell
10-47-6	Replacement: 6-3/16" 20-Tooth Carbide-Tipped Saw Blade	6	Peggable Clamshell
10-55-24	Replacement: Masonry Blade	1	Peggable Clamshell



Vacuum hose sold separately



SUPER SIX 6" JAMB SAW



The Super Six 6" Jamb Saw is a powerful, versatile undercutting tool that easily trims door jambs, baseboards, cabinet toe kicks, inside corners and most hanging doors.

- Patented design enables saw to cut full inside corners in molding up to 1/2" thick
- Spiral ground gears and ball-and-needle bearings for quiet operation and smooth blade rotation
- Adjustable cutting depth guide prevents cutting into plaster or wall board when trimming base boards
- Precision height adjustment from "flush" to 1-1/16"
- 6' cord for easier movement while cutting
- 900 watts, 120V ~ 60Hz, 7.5 AMPs motor cuts with ease

Item No.	Description	Case Qty	Packaging
10-46	Super Six 6" Jamb Saw (with carrying case)	1	Carrying Case
10-47-2	Replacement: 6-3/16" 36-Tooth Carbide-Tipped Saw Blade	2	Peggable Clamshell
10-47-6	Replacement: 6-3/16" 20-Tooth Carbide-Tipped Saw Blade	6	Peggable Clamshell

Scan Here
FOR PRODUCT INFO



JAMB SAW REPLACEMENT BLADES

Compatible with our Longneck Plus and Super Six 6" Jamb Saws, our replacement blades are designed with resilience and precision in mind.

- Designed for cutting door jambs, baseboards and along walls
- Carbide tipped for added toughness and durability
- Anti-snag blade resists catching on hidden nails
- Recessed arbor for flush cuts
- Masonry blade easily cuts through brick and cement block

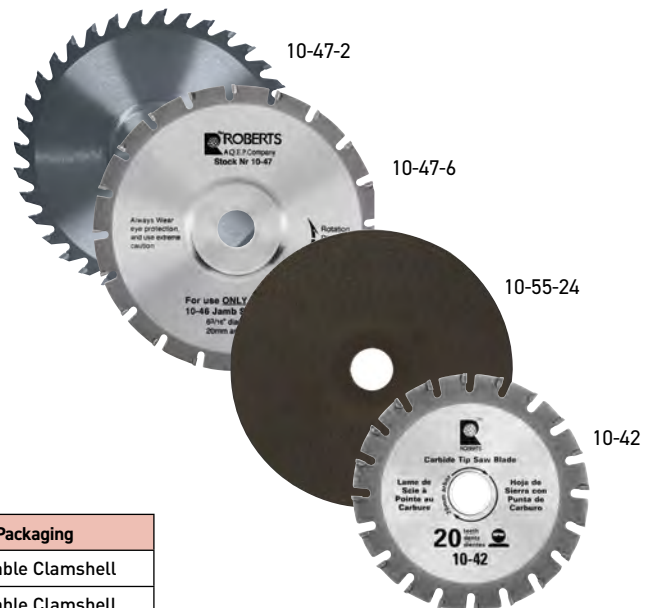

Item No.	Description	Case Qty	Packaging
10-47-2	6-3/16" 36-Tooth Carbide-Tipped Saw Blade	2	Peggable Clamshell
10-47-6	6-3/16" 20-Tooth Carbide-Tipped Saw Blade	6	Peggable Clamshell
10-55-24	6" Durable Masonry Blade	1	Peggable Clamshell
10-42	4 1/4" 20-Tooth Carbide-Tipped Saw Blade	6	Peggable Clamshell



TACK STRIP

One of the most important tools in carpet installations, the tack strip ensures that your carpet stays locked in position. Once gripped, they help to keep the seams of your carpet tight and prevent it from stretching out of shape over time.

SMOOTH EDGE PEEL & STICK CARPET TACK STRIP

Designed to make carpet installation quick and easy, the Smooth Edge Peel & Stick Carpet Tack Strip instantly grips carpet and allows for immediate stretching.

- Perfect for installing carpeting over wood or concrete subfloors
- Suitable for commercial or residential applications
- Grips instantly, immediately ready for stretching
- Manufactured using Carb Phase II and TSCA title VI compliant materials
- Covers 360 lineal feet



Item No.	Description	Case Qty	Packaging
20-1450	Smooth Edge Peel & Stick Carpet Tack Strip (3-pk) 7/8" wide x 4' long	30 Packs (90 each)	Display Carton

PROFESSIONAL 2" STRIP CUTTER

Forged from rugged steel construction, the Professional 2" Strip Cutter is designed to cut tack strip and architectural strip without extra effort.

- Powerful cutting force, 8-to-1 leverage
- Blade storage in handle



**made in
USA**

Item No.	Description	Case Qty	Packaging
10-108	Professional 2" Strip Cutter	3	Pegged Card
10-439	Replacement: 6 Strip Cutter Blades (6 blades per pack: 60 blades)	10	Blister Card



A CUT ABOVE

SCAN HERE FOR
PRODUCT INFO



Featuring a cushioned grip and stainless steel blades, QEP's **Multi-Use Trim Shears** quickly cut quarter rounds, tile trim, PVC piping, rubber hose, tack strips and more!



10711

10 GAUGE CONCRETE NAILS

Featuring a heavy 10-gauge shank, the 5/8" Concrete Nail is ideal for use on extremely hard or aged concrete where a 12-gauge nail could bend or break.

- Precision-ground blade for added sharpness and durability
- Hard nails feature a short and thick shank with excellent piercing and fixing strength
- Manufactured for use with a carpet tack strip over concrete subfloors during carpet installation



Item No.	Description	Case Qty	Packaging
33-100	5/8" Concrete Nails (1 lb. bag)	10	Poly-bag

NAIL DRIVING BAR

The Nail Driving Bar is the perfect solution for hammering nails in hard-to-reach places including under radiators, toe kicks, overhangs and next to glass doors.

- Magnetic head holds nails in place for easy starting
- 12-3/8" length helps access hard to reach areas
- Steel construction provides extra durability and extends product life
- Soft, non-slip handle helps improve handling



Item No.	Description	Case Qty	Packaging
10-151	Nail Driving Bar	6	Printed Carton



VINYL TOOLS

Improve the speed and efficiency of your next flooring install with rugged, easily transportable vinyl tools. From professional floor and tabletop cutters to flooring rollers and trimmers, our products are designed to support precision, improve efficiency, and help ensure success with your vinyl flooring installation project.

18" PRO VINYL TILE CUTTER



The 18" Pro Vinyl Tile Cutter can rip-cut vinyl flooring up to 18" (12" diagonally) and up to 1/8" thick. Specially designed to cut solid vinyl tile, vinyl composition tile (VCT), luxury vinyl tile and cork tile.

- Cutting guide and 45° miter guide ensures accurate cutting
- Hardened, adjustable 18" steel blade ensures clean, precise cuts
- Built-in casters for greater maneuverability
- Rubber feet improve stability to hold steady while cutting
- Durable, lightweight aluminum base with slotted handle to easily carry



Scan Here
FOR PRODUCT INFO



Item No.	Description	Case Qty	Packaging
10-918	18" Pro Vinyl Tile Cutter	1	Printed Carton

12" PRO VINYL TILE CUTTER



The 12" Pro Flooring Cutter is specially designed to cut solid vinyl tile, vinyl composition tile (VCT), luxury vinyl tile and cork tile. Delivers precise rip-cuts on flooring up to 12" (9" diagonally) and up to 1/8" thick.

- Adjustable cutting guide and 45° miter guide ensures accurate cutting
- Hardened, adjustable 12" steel blade ensures clean, precise cuts
- Built-in casters for greater maneuverability
- Rubber feet improve stability to hold steady while cutting
- Includes custom blow-molded carrying case



Scan Here
FOR PRODUCT INFO



Item No.	Description	Case Qty	Packaging
10-900	12" Pro Vinyl Tile Cutter	1	Printed Carton

12" VINYL TILE CUTTER



The 12" Vinyl Tile Cutter is ideal for quick and repetitive cutting of 12" x 12" vinyl tile up to 4mm thick.

- Hardened steel blade delivers accurate cuts and durability
- Built-in ruler provides cutting guide
- Molded handle provides firm, comfortable grip
- Locking blade for safety and convenient handle for easy transport



Scan Here
FOR PRODUCT INFO



Item No.	Description	Case Qty	Packaging
10-895	12" Vinyl Tile Cutter	3	Printed Carton

QUIK-CUT VINYL TILE CUTTER



The Quik-Cut Vinyl Tile Cutter cuts vinyl tiles up to 12" x 12" and up to 4mm thick.

- Die-cast aluminum base for added durability
- Built-in measuring gauge for cutting accuracy
- Hardened steel blades
- Ball and needle bearings for precise operations



Scan Here
FOR PRODUCT INFO



Item No.	Description	Case Qty	Packaging
30002	Quik-Cut Vinyl Tile Cutter	3	Printed Carton

VINYL SEAM ROLLER



The Vinyl Seam Roller is used to secure wall base and roll seams on VCT and sheet vinyl.

- 2" x 2" polished steel roller mounted on two smooth rolling ball bearings for quick, easy use
- Rounded outside edge to prevent marring or scratching walls and flooring
- Designed for superior grip and better leverage



Item No.	Description	Case Qty	Packaging
10-964	Vinyl Seam Roller	6	Tagged & Display Box

TOPSET GOUGE

This handy tool has a U-shaped, wide blade for grooving the back of vinyl or rubber cover base materials, permitting the material to be neatly bent around corners.

- 5/32" blade adjusts for depth and can be sharpened
- Hardwood handle for comfortable use



Made in Canada



Item No.	Description	Case Qty	Packaging
10-279	Topset Gouge	12	Half Clamshell

VINYL FLOORING ROLLER



Ideal for pressing VCT, linoleum, carpet, sheet vinyl, cork underlayment and other floor applications into adhesive. Designed with heavy-duty flooring rollers to evenly distribute and flatten adhesive build-up, ensuring a level installation.

- Segmented, chrome-plated rollers ensure even pressure into flooring
- Designed with inset axles to prevent wall scuffing
- Removable 30" handle for convenient storage

Item No.	Description	Case Qty	Packaging
10-935	35 lb. Vinyl & Linoleum Flooring Roller	1	Box
10-952-04	Replacement: Transport Wheel Assembly Kit	1	Box

* For heavier rollers, see page 15.

⚠ WARNING: Cancer and Reproductive Harm - www.P65Warnings.ca.gov. See P. 75, *Prop 65 - 1.



Scan Here
FOR PRODUCT INFO



POWER-LOK® EXTENDIBLE FLOOR ROLLER



Designed with the professional installer in mind, the Power-Lok® Extendible Floor Roller is a "must have" for installing a wide assortment of flooring including sheet vinyl, VCT and linoleum. Spring-loaded metal collar locks, extends and retracts length quickly.

- 7 locking positions extends length from 18" to 28"
- Quick-release mechanism for easy length adjustment
- Recessed roller hardware protects against damage to floors or walls
- Segmented rollers provide even pressure and maximum transfer of adhesive to the floor covering
- Smooth metal handgrip leverages body weight for improved control and increased pressure



Item No.	Description	Case Qty	Packaging
10-975	Power-Lok Extendible Flooring Roller	1	Half Clamshell

Scan Here FOR PRODUCT INFO



⚠WARNING: Cancer and Reproductive Harm - www.P65Warnings.ca.gov. See P. 75. *Prop 65 - 1.

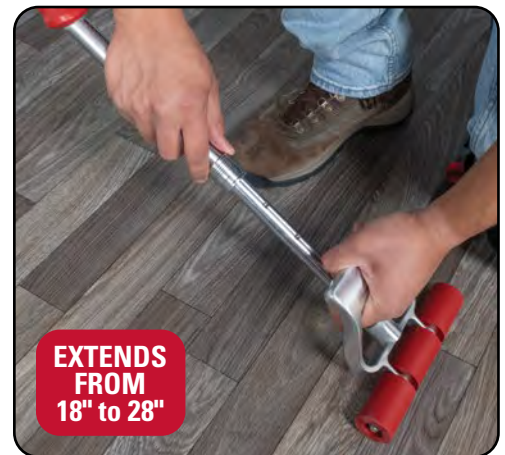

EXTENDIBLE FLOOR ROLLER



Ideal to use when installing sheet vinyl, VCT, linoleum, carpet and cove base. The Extendible Floor Roller features non-marking, segmented rollers to maximize and level the transfer of adhesive to the floor covering.

- Handle extends from 17 to 27" to access hard to reach places like under the overhang of a cabinet toe-kick
- Designed with 7-7/8" non-marking rollers and inset axles to prevent wall scuffing
- Second handle for additional leverage
- Twist-lock handle for easy length adjustment

Item No.	Description	Case Qty	Packaging
10-955	Extendible Floor Roller	2	Half Clamshell



⚠WARNING: Cancer and Reproductive Harm - www.P65Warnings.ca.gov. See P. 75. *Prop 65 - 1.



WOOD & LAMINATE TOOLS

Specifically engineered for the installation of wood and laminate floors, our multi-floor cutters, installation kits, putties and individual flooring tools are precision crafted, thoughtfully designed and take into account feedback of today's top installers. Rugged, durable, dependable and reusable, these wood and laminate flooring tools are ready to take on your next installation project.

INTRODUCING PRECISIONCUTS™ PRO MULTI-FLOOR CUTTERS

AVAILABLE IN 25", 18", 13" AND 9"



Built-in ruler features both inches and millimeters for convenience



Built-in light for improved cutting view

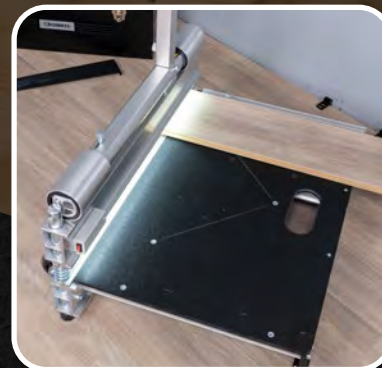

Cutting guide accommodate straight edges or angled cuts

25" PRECISIONCUTS™ PRO MULTI-FLOOR CUTTER



Precision designed to quickly cut carpet tile, laminate, engineered wood flooring, vinyl plank flooring, siding, VCT tile, PVC and other flooring applications. The 25" PrecisionCuts Pro Multi-Floor Cutter trims flooring up to 25" wide, 17" diagonal and 5/8" (16 mm) thick.

- Built in light (with on /off switch) for improved cutting view
- Large steel rollers for smooth action and increased cutting power
- Built-in ruler features both inches and millimeters
- Incorporated toggle switch to lock blade in place
- Thicker blade carriage for more force in cutting
- Cutting blade accommodate straight edges or angled cuts
- Ideal for carpet tile
- Replaceable, resharpenable tungsten blade



Scan Here
FOR PRODUCT INFO



Item No.	Description	Case Qty	Packaging
10-959	25" PrecisionCuts™ Pro Multi-Floor Cutter	1	Printed Carton
10-468	Replacement: 25" Tungsten Carbide Blade	1	Clamshell

18" PRECISIONCUTS™ PRO MULTI-FLOOR CUTTER



Precision designed to quickly cut carpet tile, laminate, engineered wood flooring, vinyl plank flooring, siding, VCT tile, PVC and other flooring applications. The 18" PrecisionCuts Pro Multi-Floor Cutter trims flooring up to 18 wide, 12.5" diagonal and 5/8" (16 mm) thick.

- Built in light (with on /off switch) for improved cutting view
- Large steel rollers for smooth action and increased cutting power
- Built-in ruler features both inches and millimeters
- Incorporated toggle switch to lock blade in place
- Thicker blade carriage for more force in cutting
- Cutting blade accommodate straight edges or angled cuts
- Replaceable, resharpenable tungsten blade



Scan Here
FOR PRODUCT INFO



Item No.	Description	Case Qty	Packaging
10-997	18" PrecisionCuts™ Pro Multi-Floor Cutter	1	Printed Carton
10-990	Replacement: 18" Tungsten Carbide Blade	1	Clamshell

13" PRECISIONCUTS™ PRO MULTI-FLOOR CUTTER



Precision designed to quickly cut carpet tile, laminate, engineered wood flooring, vinyl plank flooring, siding, VCT tile, PVC and other flooring applications. The 13" PrecisionCuts Pro Multi-Floor Cutter trims flooring up to 13" wide, 8.5" diagonal and 5/8" (16 mm) thick.

- Built in light (with on /off switch) for improved cutting view
- Large steel rollers for smooth action and increased cutting power
- Built-in ruler features both inches and millimeters
- Incorporated toggle switch to lock blade in place
- Thicker blade carriage for more force in cutting
- Cutting blade accommodate straight edges or angled cuts
- Replaceable, resharpenable tungsten blade



Scan Here
FOR PRODUCT INFO



Item No.	Description	Case Qty	Packaging
10-942	13" PrecisionCuts™ Pro Multi-Floor Cutter	1	Printed Carton
10-940	Replacement: 13" Tungsten Carbide Blade	1	Clamshell

9" PRECISIONCUTS™ PRO MULTI-FLOOR CUTTER



Precision designed to quickly cut carpet tile, laminate, engineered wood flooring, vinyl plank flooring, siding, VCT tile, PVC and other flooring applications. The 9" PrecisionCuts Pro Multi-Floor Cutter trims flooring up to 9" wide, 5.5" diagonal and 5/8" (16 mm) thick.

- Built in light (with on /off switch) for improved cutting view
- Large steel rollers for smooth action and increased cutting power
- Built-in ruler features both inches and millimeters
- Incorporated toggle switch to lock blade in place
- Thicker blade carriage for more force in cutting
- Cutting blade accommodate straight edges
- Replaceable, resharpenable tungsten blade



Scan Here
FOR PRODUCT INFO



Item No.	Description	Case Qty	Packaging
10-911	9" PrecisionCuts™ Pro Multi-Floor Cutter	1	Printed Carton
10-910	Replacement: 9" Tungsten Carbide Blade	1	Clamshell

18" MULTI-FLOOR CUTTER



Manufactured to quickly cut laminate, engineered wood flooring, vinyl plank flooring, siding, VCT tile, PVC and more. Ideal for cutting flooring up to 18" wide, 12.5" diagonal and 16 mm thick, the 18" Multi-Floor Cutter.

- Extended handle provides extra leverage for more cutting power with less effort
- Cutting guide swivels for angle cuts and is adjustable to maintain perfect 90° cuts
- Extruded aluminum support base with a comfortable, solid plastic working area
- Replaceable, resharpenable tungsten blade



Scan Here
FOR PRODUCT INFO



Item No.	Description	Case Qty	Packaging
10-99	18" Multi-Floor Cutter	1	Printed Carton
10-990	Replacement: 18" Tungsten Carbide Blade	1	Clamshell

9" MULTI-FLOOR CUTTER



Manufactured to quickly cut carpet tile, laminate, engineered wood flooring, vinyl plank flooring, LVT and VCT tile. The 9" Multi-Floor Cutter trims flooring up to 9" wide, 5.5" diagonal and 16 mm thick.

- Extended handle provides extra leverage for more cutting power with less effort
- Extruded aluminum support base with a comfortable, solid plastic working area
- Replaceable, resharpenable tungsten blade



Scan Here
FOR PRODUCT INFO



Item No.	Description	Case Qty	Packaging
10-91	9" Multi-Floor Cutter	1	Printed Carton
10-910	Replacement: 9" Tungsten Carbide Blade	1	Clamshell

13" MULTI-FLOOR CUTTER



Manufactured to quickly cut laminate, engineered wood flooring, vinyl plank flooring, vinyl wood and more. The 13" Multi-Floor Cutter trims flooring up to 13" wide and 12 mm thick.

- Table miter gauge for angled cuts 0° - 45°
- Extended handle provides extra leverage for more cutting power with less effort
- Replaceable, resharpenable tungsten blade



Scan Here
FOR PRODUCT INFO



Item No.	Description	Case Qty	Packaging
10-63	13" Multi-Floor Cutter	1	Printed Carton
10-463	Replacement: 13" Tungsten Carbide Blade	1	Clamshell

9" MULTI-FLOOR CUTTER



Manufactured to quickly cut carpet tile, laminate, engineered wood flooring, vinyl plank flooring, LVT and VCT tile. The 9" Multi-Floor Cutter is made of heavy-duty steel.

- T-base design provides maximum stability
- Hardened steel blade delivers accurate cuts and durability
- Molded handle provides firm, comfortable grip
- Locking blade for safety and convenient handle for easy transport



Scan Here
FOR PRODUCT INFO



Item No.	Description	Case Qty	Packaging
10-60	9" Multi-Floor Cutter	1	Printed Carton
10-460	Replacement: 9" Tungsten Carbide Blade	1	Clamshell

⚠ WARNING: Cancer and Reproductive Harm - www.P65Warnings.ca.gov. See P. 75. *Prop 65 - 4.

8" LAMINATE & VINYL PLANK CUTTER



Blunt-blade design cuts laminate and vinyl plank flooring up to 8" wide and 10 mm thick, the 8" Laminate & Vinyl Plank Cutter is made of heavy-duty steel.

Scan Here
FOR PRODUCT INFO



- Features blunt, no-sharp cutting edge that prevents laminate from splitting
- Non-slip grip for max comfort and superior leverage
- Sturdy, positionable V support keeps planks level while cutting

Item No.	Description	Case Qty	Packaging
10-35	8" Laminate & Vinyl Plank Cutter	1	Printed Carton



REPLACEMENT FLOORING CUTTER BLADES

Featuring long-lasting 4 mm tungsten blades, ROBERTS® Replacement Flooring Cutter Blades ensure sharp, clean cutting edge.

Item No.	Description	Case Qty	Packaging
10-468	Replacement: 25" Blades for 10-95	1	Clamshell
10-910	Replacement: 9" Blades for 10-91	1	Clamshell
10-940	Replacement: 13" Blades for 10-94	1	Clamshell
10-990	Replacement: 18" Blades for 10-99	1	Clamshell
10-460	Replacement: 9" Blades for 10-60	1	Clamshell
10-463	Replacement: 13" Blades for 10-63	1	Clamshell



PRO FLOORING INSTALLATION KIT



Ideal for use with vinyl, laminate, and hardwood flooring installations. The Pro Flooring Installation kit is designed for floating or glue-down installations.

Kit includes: 30 Dual Expansion Joint Spacers, Universal Tapping Block, Wide Angle Pull Bar, and a Double-Faced Mallet



Item No.	Description	Case Qty	Packaging
10-43	Pro Flooring Installation Kit	6	Printed Carton

DUAL EXPANSION JOINT SPACERS



For use with floating or glued vinyl, laminate or hardwood flooring installations. The Dual Expansion Joint Spacers form 1/4" and 1/2" expansion joints and create 1" thresholds.

- Provides space along the room perimeter to allow for expansion and contraction of flooring
- Self-bracing to remain upright throughout installation
- Made of durable, hard plastic that resist compression

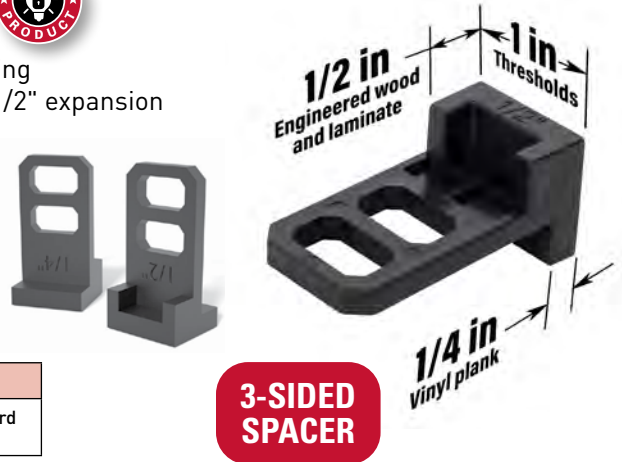

Item No.	Description	Case Qty	Packaging
10-36	Dual Expansion Joint Spacers (30 Count)	8	Peggable Hang Card with Polybag

FLOORING INSTALLATION KIT



The Flooring Installation Kit is used to install tongue and groove flooring as well as glue-down and floating floor applications.

Kit includes: Tapping Block, Pull Bar, and Wedge Spacers



Item No.	Description	Case Qty	Packaging
10-26	Flooring Installation Kit (30 Wedge Spacers)	10	Printed Carton
10-28	Flooring Installation Kit (50 Wedge Spacers)	6	Printed Carton

EXPANSION JOINT WEDGE SPACERS

Expansion Joint Wedge Spacers are designed to create space between the floor material and wall in floating flooring installations.

- Prevents flooring from moving during installation
- Made of durable, hard plastic that resist compression
- Serrated surface locks wedge spacer into position once plank is placed against it

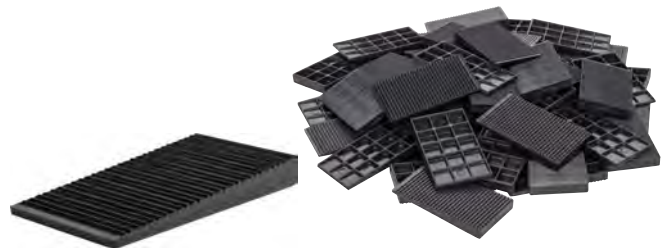

Item No.	Description	Case Qty	Packaging
10-27	Expansion Joint Wedge Spacers (30 wedges)	6	Polybag

UNIVERSAL TAPPING BLOCK



Uniquely engineered with dual-purpose edges, the Universal Tapping Block is specifically designed for resilient vinyl tile, plank flooring, tongue and groove floors, and click-lock floors.

- Two-sided design accommodates click-lock or tongue and groove flooring
- Protects flooring edge from damage

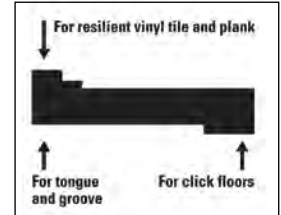

Combination Edge Design

Item No.	Description	Case Qty	Packaging
10-25	Universal Tapping Block	8	Label

DOUBLE TAP™ REVERSIBLE TAPPING BLOCK



ROBERTS® 10" Double Tap™ Reversible Tapping Block is designed to push flooring planks together without damaging the joining grooves of the flooring or your fingers.

- Double-sided with notches designed for tongue and groove, as well as click-lock laminate, engineered wood, or vinyl tile planks
- D-handle can be removed and reattached to either side of the block depending on flooring type installed
- Offset handle keeps hands and fingers away from strike zone



Scan Here
FOR PRODUCT INFO



Item No.	Description	Case Qty	Packaging
10-49	Double Tap™ Reversible Tapping Block	8	Printed Wrap

⚠️WARNING: Cancer and Reproductive Harm - www.P65Warnings.ca.gov. See P. 75. *Prop 65 - 1.

THE MAVERICK™ WIDE ANGLE PULL BAR

ROBERTS® THE MAVERICK™ Wide Angle Pull Bar helps tighten seams during laminate, vinyl and wood flooring installation.



- Triangle-shaped head can withstand 10 times the strike force of N-shaped pull bars
- Extra-long 16" length for better maneuverability
- Reaches against a wall cabinet, toe kick or other hard to reach spaces where a tapping block will not fit
- Forged from premium steel construction for durability
- Soft felt pads protect against damage to floors

Item No.	Description	Case Qty	Packaging
10-018	THE MAVERICK™ Wide Angle Pull Bar	6	Label



PRO PULL BAR

Forged from premium steel construction, the Pro Pull Bar is used to gently pull together planks of floating floors and glue-down installations of all brands of tongue and groove flooring. Ideal for use in tight spaces, and against walls.

- 16½" long, angled profile allows planks to be tapped together in tight areas and at walls
- Premium steel construction
- Soft felt pads protect against damage to floors

Item No.	Description	Case Qty	Packaging
10-18-8	Pro Pull Bar	8	Label





UNIVERSAL TOOLS

One of the greatest attributes of a tool in an installer's toolbox is its ability to be used in numerous installation environments or for different types of projects. With this versatility in mind, we offer heavy cargo dollies and dual air gliders, knee pads, scrapers and other tear-out tools to help transport furniture / heavy equipment, remove unwanted flooring debris, and prepare subfloors for new installation projects.

HEAVY CARGO DOLLIES



Expertly manufactured for transporting heavy loads. The Heavy Cargo Dollies are ideal for moving rolls of carpet, sheet goods, furniture, appliances and equipment.

- Each dolly holds up to 1000 lbs.
- Made from heavy industrial steel, with welded and bolted construction
- Extends from 24" to 33" with spring-loaded lock pins
- 3" heavy-duty ball bearing, non-marring polyurethane wheels make transporting easier and faster



Item No.	Description	Case Qty	Packaging
10-575	Heavy Cargo Dollies (Set of 2)	1	Plain Box

DUAL AIR GLIDER



Functioning much like a hovercraft, the Dual Air Glider can lift up to 750 lbs. to transport furniture, appliances and machinery without damaging floors.

- 1.75 (120 V) HP blower provides a 750 lbs. lift capacity
- 8½" x 36" dual vacuum platforms
- Improved motor output connector
- Includes carrying case



Scan Here
FOR PRODUCT INFO



Item No.	Description	Case Qty	Packaging
10-480	Dual Air Glider (120 V)	1	Plain Box



PRO CARPET KNEE PADS

Specifically designed for installers, Pro Carpet Knee Pads provide cushioning and support to knees.

- Padded upper strap specifically designed to be used during knee kicking
- Soft, wide straps hold knee pads in place without pinching
- Elastic pencil holder built in



Item No.	Description	Case Qty	Packaging
79034	Pro Carpet Knee Pads	6	Peggable Hang Card

HARD CAP KNEE PADS

Skateboard-style pads, Hard Cap Knee Pads help prevent knee injury and provide comfort while installing carpet.

- Hard cap glides easily on soft flooring
- Nylon fabric with foam cushion for comfort
- Adjustable hook and loop straps ensures the right fit



Item No.	Description	Case Qty	Packaging
79023-6	Hard Cap Knee Pads	6	Peggable Hang Card

CARPET PULLER

The Carpet Puller is ideal to tear out and remove glued-down carpet (without a pad), double glued-down carpet (with a pad) and stretch-in carpet installations.

- Serrated clamps ensure firm carpet grip, ideal for removing carpet
- Die-cast aluminum provides maximum pulling power
- Large comfortable handle for improved grip



Item No.	Description	Case Qty	Packaging
10-10	Carpet Puller	2	Trapped Blister

⚠️WARNING: Cancer - www.P65Warnings.ca.gov. See P. 75, *Prop 67 - 2.

PRO MINI PRY BAR

Made of high-carbon forged steel, the Pro Mini Pry Bar is ideal to remove base molding and tack strip.

- 32° angle provides ideal leverage
- Deep bevel nail slot for easy nail removal
- Versatile 10½" tool is built to last and small enough to fit in your toolbox



32°
IMPROVED ANGLE

Item No.	Description	Case Qty	Packaging
10-503	Pro Mini Pry Bar	3	Pegged Hang Card

20-OZ. RIPPING HAMMER

Featuring a contoured handle and American hickory construction, the 20 oz. Ripping Hammer provides optimal strength and minimizes impact shock while installing new tack strip.

- Long straight claw is ideal for pulling up old tack strip
- 14" long and 20-oz. head



Item No.	Description	Case Qty	Packaging
10-114	20 oz. Ripping Hammer	6	Printed Carton

PRO FLOOR & WALL SCRAPER

The heavy-duty construction of the Pro Floor & Wall Scraper removes tough materials like stubborn glue and old flooring material, leaving surfaces smooth and prepped.

- Ball cap fits in the palm of your hand for comfortable scraping
- Designed for less user fatigue
- Ideal for a variety of wall and floor stripping applications



Item No.	Description	Case Qty	Packaging
10-188	Pro 4" Floor & Wall Scraper (18" Handle)	6	Pegged Hang Card
10-442-10	Replacement: 4" Floor & Wall Scraper Blade (10 Pack)	10	Hang Card

HEAVY-DUTY 6" CONVERTIBLE SCRAPER



Rugged and dependable, Heavy-Duty 6" Convertible Scraper with adjustable handle is the ideal tool to remove adhesive, carpet, tile and other flooring materials.

- Easily converts to a stand-up scraper with the addition of a stretcher extension tube (sold separately)
- Action lock handle adjusts 360° to any position
- Comfortable molded handle maximizes thrust and conserves energy



Scan Here
FOR PRODUCT INFO



Item No.	Description	Case Qty	Packaging
10-195	Heavy-Duty 6" Convertible Scraper	1	Carton
10-195-01	Replacement: 6" Hardened Steel Blade	1	Carton
10-230-10	Accessory: 3' Steel Stretcher Tube	1	Carton

4" FLOOR AND WALL SCRAPER & STRIPPER

4" Floor and Wall Scraper & Stripper is the ideal tool for stripping floors and walls, as well remove adhesive, paint and other installation residues.

- Angled head provides "clean shaving" cutting action
- Flex-grip, anti-fatigue vinyl hand grip
- Features three blade clamp screws for maximum blade holding power



Item No.	Description	Case Qty	Packaging
10-194	4" Floor and Wall Scraper & Stripper (12" Handle)	10	Clamshell
10-294	4" Floor and Wall Scraper & Stripper (18" Handle)	10	Clamshell
10-442-10	Replacement: 4" Floor & Wall Scraper Blade (10 Pack)	10	Hang Card

STAND-UP SCRAPER



The Stand-Up Scraper is ideal to remove old adhesive, vinyl, carpet, tile and other floor covering materials. Sturdy construction with an 8" hardened steel blade.

- Deluxe cushioned grip handle, adjustable from 3' to 6'
- Sturdy construction with an 8" hardened steel blade and locking cam
- Steel shank molded into head, welded to steel handle
- 15° angled head reaches underneath toe kicks and other small spaces



Item No.	Description	Case Qty	Packaging
10-296	Stand-Up Scraper	6	Clamshell
10-458	Replacement: 8" Floor & Wall Scraper Blade (10 Pack)	10	Carton

FLOOR & WALL SCRAPER BLADES

Floor & Wall Scraper Blades are made of precision ground high speed carbon steel blade for sharpness and durability to yield professional results.

Item No.	Description	Case Qty	Packaging
10-442-10	4" Floor & Wall Scraper Blades (4" long x 0.15" thick) 10 packs of 10 Blades: 100 Blades For use with 10-187, 10-188, 10-194, 10-294 and all standard 4" scrapers	10	Hang Cards
10-458	8" Floor & Wall Scraper Blades (8" long x 0.74" wide x 0.15" thick) 10 packs of 1 Blade: 10 Blades For use with 10-296 and all standard 4" scrapers	1	Peggable Card

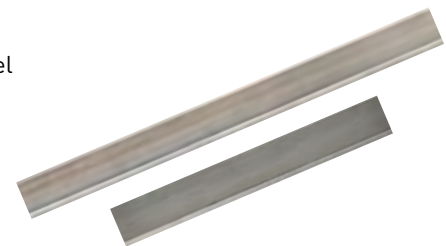

made in
USA

* For Replacement Knife Blades, see page 26. For Replacement Floor Cutter Blades, see page 42.

DELUXE GRIP POUCH

The Deluxe Grip Pouch holds tools firmly in place with special leather insert grips.

- 100% double-stitched leather for extended wear and longer product life
- Slotted to fit directly on a belt
- 7½" x 4½" x 3/4" with one large pocket

Item No.	Description	Case Qty	Packaging
10-260	Deluxe Grip Pouch	12	Pegged Card

made in
USA



CHALK & LINE REEL

The Chalk & Line Reel ensures straight lines and installations on a variety of building applications.

- 100' abrasion-resistant poly line
- Robust steel handle and large center hub for increased durability, strength and torque
- Wide door for quick and easy chalk fill
- Tear-drop shape for use as a plumb bob

Item No.	Description	Case Qty	Packaging
10-303S	Chalk & Line Reel	6	Carton
10-321	Replacement: White Chalk Refill (8 oz.)	24	Carton



30' TAPE MEASURE

Durable and easy to read, the 30' Tape Measure can be used indoors and outdoors.

- Rugged case with red rubber jacket
- Larger numbers for improved readability
- Strong spring return; thumb lock and steel belt clip
- The 1" blade is steel acrylic coated to ensure durability

Item No.	Description	Case Qty	Packaging
10-140	30' Tape Measure	12	Pegged Card



MOZART WELD ROD TRIMMER

- Includes swiveling MOZART spacer claw, eliminating need for guide plate
- No sharpening needed
- Helps prevent damage to the floor covering
- Includes interchangeable, industrially manufactured, economical trimming blades

Item No.	Description	Case Qty	Packaging
10-1600	Mozart Weld Rod Trimmer (Canada Only)	1	Carton
10-8678	Replacement: Mozart Trimmer Blades (5 Pack Card)	10	Carton
10-8679	Replacement: Mozart Trimmer Scraper Claw (0.5 mm)	10	Carton
10-8700	Replacement: Mozart Trimmer Scraper Claw (0.7 mm)	10	Carton
10-041	Replacement: Fixing Attachments (1 Screw & 3 Washers)	10	Carton



Canada Only





WOOD, LAMINATE & VINYL PUTTY

Acrylic based and easy to use, the putty is used to fill gaps, nicks and scratches on wood, laminate and vinyl flooring.

- Features six on-trend colors to match a wide variety of flooring
- Dries in 30 minutes
- Easy to paint or sand
- No cracking or shrinking
- Use during floor installation to fill nail and screw holes, or to repair damage on existing floors



Item No.	Description	Case Qty	Packaging
PC7725	Brown Repair Putty	6	3 oz. Tube
PC7726	Light Repair Putty	6	3 oz. Tube
PC7728	Gray Repair Putty	6	3 oz. Tube
PC7730	Tan Repair Putty	6	3 oz. Tube
PC7732	Dark Brown Repair Putty	6	3 oz. Tube
PC7733	Light Gray Repair Putty	6	3 oz. Tube



UNIVERSAL REPAIR KIT



The Universal Repair Kit is designed to repair cracks, scratches or other damage to wood floors, vinyl floors and counters, wood cabinets, molding and furniture.

- Features five colors and an empty container for custom mixing to match any project
- Easy to sand and stain
- Quick drying and no shrinking



Item No.	Description	Case Qty	Packaging
10-33	Universal Repair Kit	6	Clamshell

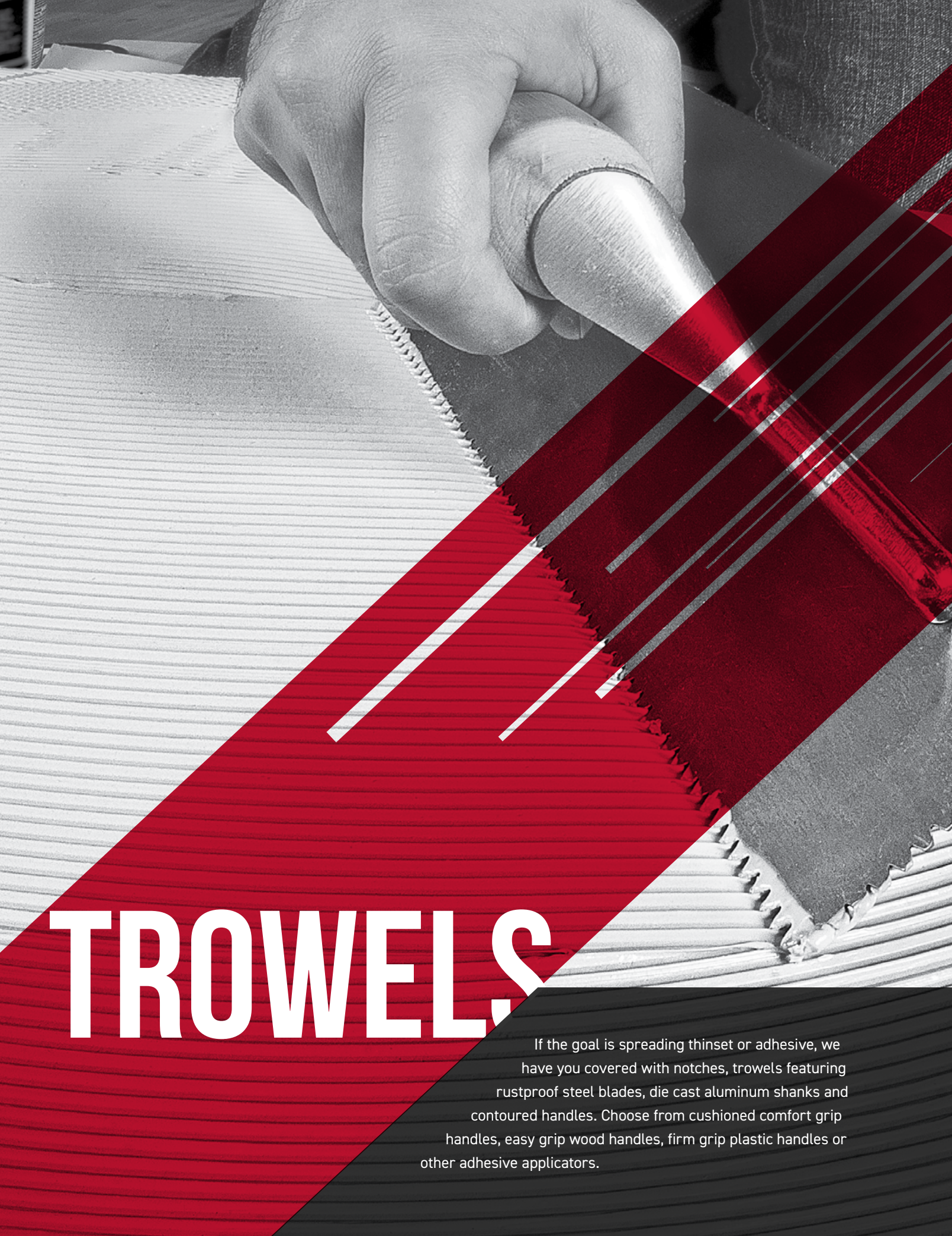

TROWELS

If the goal is spreading thinset or adhesive, we have you covered with notches, trowels featuring rustproof steel blades, die cast aluminum shanks and contoured handles. Choose from cushioned comfort grip handles, easy grip wood handles, firm grip plastic handles or other adhesive applicators.

COMFORT GRIP TROWELS

#1 PROVEN PERFORMANCE
LONGEST LASTING
BLADE IN THE INDUSTRY*

High-quality 11" x 4½" trowel with rustproof stainless-steel blade and large, contoured, and cushioned grip handles for comfort.

- Durable 230 mm zinc die-cast shank with nine rivets
- Extra handle-to-shank clearance to allow for complete hand rotation
- Longer, cast aluminum shank with nine rivets for durability
- First and last rivet reinforced and welded for longer product life



*3rd Party Independent Testing Performed by CARTA

WOOD HANDLE TROWELS



High-quality 11" x 4½" trowel with hardened and tempered steel blade and large wooden handle for an easy grip.

- Blade is grounded and polished for lasting durability
- Long, die-cast aluminum shank
- First and last rivets reinforced and welded for added durability



ECONOMY NOTCHED TROWELS

Engineered for extended wear and tear, Economy Notched Trowels are designed for application of pressure sensitive, resilient adhesives.

- Cold-rolled 9" steel blade for longer wear
- High-impact, black plastic handle for firm, comfortable grip

made in
USA



COVE BASE ADHESIVE SPREADER





Manufactured with a cold-rolled steel blade for durability, the Cove Base Adhesive Spreader is designed to spread adhesive for a flat, well-bonded cove base installation.

- Fits into a 1 qt. canister of adhesive for quicker, easier application
- Wood handle for comfort
- Features 3/16" x 5/32" V-Notch

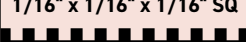
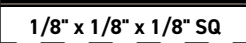
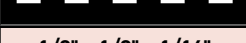

Item No.	Description	Case Qty	Packaging
10033	Cove Base Adhesive Spreader	24	Label & Display Box

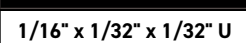
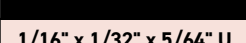
FOR CARPET, VINYL SHEET, LVT, VCT & WOOD

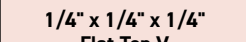
Notch Size	Application	Comfort Grip (11" Blade)	Wood Handle (11" Blade)	Economy
1/16" x 1/16" x 1/16" SQ 	For carpet tile, fiberglass sheet, felt-backed sheet, luxury vinyl tile, plank, and cork underlayment		49768	10-181*
1/16" x 1/16" x 1/16" SQ 	For carpet tile, fiberglass sheet, felt-backed sheet, luxury vinyl tile and plank	10-823 (with 10° blade angle)	10-810 (with 10° blade angle)	
1/8" x 1/8" x 1/8" SQ 	For pre-finished parquet and wall base		49766	
1/8" x 1/8" x 1/16" Flat-Top V 	For secondary-backed carpet, direct glue-down, sheet vinyl installations, and cork underlayment		49737	10137-12
1/16" x 1/32" x 1/32" U 	For VCT, vinyl, luxury vinyl tile and plank		49771	10-181*
1/16" x 1/32" x 5/64" U 	For carpet tile, fiberglass sheet, felt-backed sheet, and VCT		49738	
1/4" x 1/4" x 1/4" SQ 	For thinset application of ceramic tile 8" x 8" or smaller, laminated wood plank flooring, flat milled solid & shorts or plywood	49915 (QEP)	49713 (QEP)	10113 (QEP)
1/4" x 1/4" x 1/4" Flat-Top V 	For pre-finished engineered wood plank, solid wood, bamboo and acrylic impregnated plank flooring		49769	
1/4" x 3/16" Tiger Tooth® 	For bamboo, solid and engineered wood flooring up to 1/2 in. thick		49767	
3/16" x 1/4" x 1/2" Flat-Top V 	For laminated wood plank, solid wood, bamboo and acrylic impregnated plank flooring		49730	

* Double Sided Trowels

Always check adhesive/mortar manufacturer's trowel recommendations before selecting a trowel notch.

All trowels measure: width x depth x space apart

Recommended notch sizes by NTCA (National Tile Contractors Association)

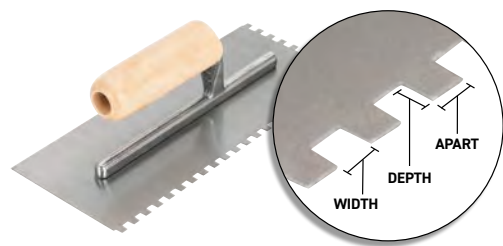

SNOZZLE ADHESIVE APPLICATOR

The SNOZZLE Adhesive Applicator creates a flat, well-bonded installation by spreading 11 rows of adhesive at a time.

- Compatible with 11 oz. and 30 oz. adhesive cartridges and fits most standard applicator guns
- Distributes adhesive in tight spaces where a standard trowel can't be used
- Ideal for cove base or flooring plank repair



Scan Here FOR PRODUCT INFO



Item No.	Description	Case Qty	Packaging
10-981-25	Snozzle Adhesive Applicator	25	Hang Tag & Display Box
10-981	Canada Only: Snozzle Adhesive Applicator	25	Pegged Hang Tag

made in USA

WIDER PLANKS? No problem.

new!

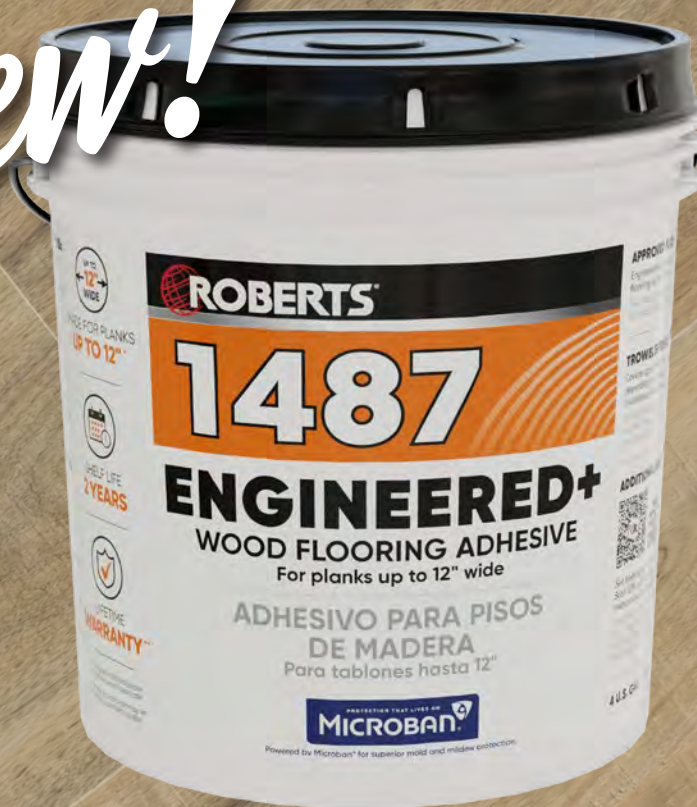

MOLD & MILDEW
DEFENSE



MADE FOR PLANKS
UP TO 12"*



SHELF LIFE
2 YEARS



LIFETIME
WARRANTY**

ROBERTS® 1487 ENGINEERED+ WOOD FLOORING ADHESIVE

is formulated for engineered planks up to 12" wide and 5/8" thick*. Backed by a Lifetime Warranty**, ROBERTS 1487 is the **only** wood flooring adhesive to feature Microban®, the industry standard in mold and mildew protection.

Scan Here
FOR PRODUCT INFO





UNDER LAYMENT

Indispensable to protecting your floors against moisture, mold and mildew damage, ROBERTS® underlayments provide a layer of cushioning to the floors, reduce subfloor imperfections, and quiet footfalls and ambient noise, adding years of use and enjoyment to your floors.

FIRST STEP® PREMIUM UNDERLAYMENT

For use under floating laminate and engineered hardwood flooring, sound resistant First Step® Premium Underlayment can be used above, below and on grade subfloors.



#1 BEST OVERALL LAMINATE UNDERLAYMENT FOR 2023*

Source: bobvilla.com

- 3-layer design has polystyrene beads to allow moisture to flow to the exterior to be expressed safely
- Adhesive strip and 4" overlap film help join pieces and lock out moisture
- 2-mil top-layer protects finished floor from subfloor moisture
- Outstanding compression resistance and mold / mildew defense
- Reduces ambient noise and helps level minor subfloor imperfections
- Ideal in condos and multi-level dwellings

Thickness	IIC Rating*	STC Rating*	Δ Rating*	R-Value
2 mm	68	67	20	0.432

Item No.	Description	Case Qty	Packaging
70-102-12	First Step® Premium (100 sq. ft. roll) 40" x 30'	12	Corrugate
70-102-1	First Step® Premium (630 sq. ft. roll) 40" x 189'	1	Polybag

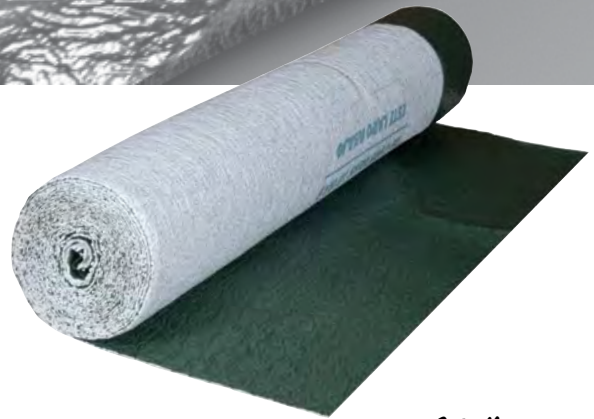

made in
USA

Scan Here
FOR PRODUCT INFO



QUIET CUSHION® UNDERLAYMENT



Comprised of extra fine, cross-linked foam for superior sound reduction, advanced moisture protection and improved shock absorption. Quiet Cushion® is ideal for use under engineered and laminate flooring.

- Anti-crush technology for excellent performance and long life
- Adhesive strip and 3" overlap film help join pieces and lock out moisture
- Excellent for radiant heat floors, mold and mildew resistant

Thickness	IIC Rating*	STC Rating*	Δ Rating*	R-Value
2 mm	71	67	21	0.253

Item No.	Description	Case Qty	Packaging
70-180	Quiet Cushion® Underlayment (100 sq. ft. roll) 43.5" x 27.5'	12	Corrugate



Scan Here
FOR PRODUCT INFO



* IIC measures sound such as moving furniture and walking, STC measures sound such as voices and television. Minimum sound rating required by most building codes and architects is 50. R-Value is the rating used to measure resistance to heat flow. Δ Delta Rating is the only true measurement of sound reduction from a product (not a floor assembly) in the industry.

SOUND BARRICADE UNDERLAYMENT



Comprised of a crushed-proof rubber blend, Sound Barricade is designed for use under vinyl, laminate or wood flooring.

- Rubber blend inhibits the growth of mold and mildew
- Rubber foam technology provides superior acoustical properties
- Retains cushion and shape through the use of recycled tire crumb materials
- Can be used for floating, nail down, staple or double-glue down installations



Scan Here
FOR PRODUCT INFO



Flooring	Thickness	IIC Rating*	STC Rating*	Δ Rating*	R-Value*
LVT & Planks	1.5 mm	69	63	25	0.205
Laminate & Wood	1.5 mm	68	63	22	0.205

Item No.	Description	Case Qty	Packaging
70-197	Sound Barricade (200 sq. ft. roll) 36" x 66'	1	Polybag

SUPER FELT® UNDERLAYMENT



For use under laminate and engineered wood flooring. Super Felt® provides premium R-Value to take the chill out of cold floors.

- 2-mil top film protects against exposure to harmful vapors and minimizes the growth of mold and mildew
- Made with 80% recycled fibers to absorb sound and minimize noise
- Adhesive strip and 3" overlap film help join pieces and lock out moisture



Scan Here
FOR PRODUCT INFO



Thickness	IIC Rating*	STC Rating*	Δ Rating*	R-Value
3 mm	67	66	21	0.58

Item No.	Description	Case Qty	Packaging
70-190	Super Felt® Underlayment (100 sq. ft. roll) 44" x 27.3'	1	Polybag
70-193	Super Felt® Underlayment (360 sq. ft. roll) 44" x 98'	1	Polybag

BLACK JACK® UNDERLAYMENT



Ideal for use above, below and on grade under laminate and engineered wood flooring. Black Jack® is made of dense, closed cell foam.

- Dense, closed cell structure offers moisture, mold and mildew resistance
- Ideal for use over radiant heated floors



Scan Here
FOR PRODUCT INFO



Thickness	IIC Rating*	STC Rating*	Δ Rating*	R-Value
2.5 mm	70	66	21	0.425

Item No.	Description	Case Qty	Packaging
70-026	Black Jack® Underlayment (100 sq. ft. roll) 43" x 28'	12	Corrugate
70-026XL	Black Jack® Underlayment (600 sq. ft. roll) 43" x 167.5'	2	Corrugate

* IIC measures sound such as moving furniture and walking, STC measures sound such as voices and television. Minimum sound rating required by most building codes and architects is 50. R-Value is the rating used to measure resistance to heat flow. Δ Delta Rating is the only true measurement of sound reduction from a product (not a floor assembly) in the industry.

SOFT STRIDE® UNDERLAYMENT



Soft Stride® is a dense foam underlayment that provides excellent sound reduction under laminate and engineered flooring.

- Closed cell foam design provides excellent moisture protection and fights against mold and mildew
- Excellent for radiant floors and ambient sound reduction
- Adhesive strip and 3" overlap film help join pieces and lock out moisture



Scan Here FOR PRODUCT INFO



Thickness	IIC Rating*	STC Rating*	Δ Rating*	R-Value
2 mm	69	66	21	0.343

Item No.	Description	Case Qty	Packaging
70-185	Soft Stride® Underlayment (100 sq. ft. roll) 43.5" x 27.5'	12	Corrugate

UNISON® 2-IN-1 UNDERLAYMENT



Unison 2-in-1® is ideal for use with laminate and engineered wood flooring. Made of 3/32" thick polyethylene foam with a top film.

- Top film protects from harmful moisture barrier
- Adhesive strip and 4" overlap film help join pieces and lock out moisture



Scan Here FOR PRODUCT INFO



Thickness	IIC Rating*	STC Rating*	R-Value
3/32"	61	54	0.29

Item No.	Description	Case Qty	Packaging
70-025	Unison® 2-in-1 Underlayment (100 sq. ft. roll) 48" x 25'	12	Corrugate

SERENITY FOAM UNDERLAYMENT



Ideal for use under laminate and engineered wood flooring. Serenity features a 3/32" thick polyethylene foam to provide cushioning between floors or subfloors.

- Adds cushioning and compensates for minor imperfections in the subfloor
- Can be used in above-grade installations and in conjunction with a moisture barrier for below grade
- Easy to roll out for fast installation



Scan Here FOR PRODUCT INFO



Item No.	Description	Case Qty	Packaging
70-010	Serenity Foam Underlayment (100 sq. ft. roll) 48" x 25'	60	Corrugate
70-010-XL	Serenity Foam Underlayment (400 sq. ft. roll) 48" x 100'	1	Corrugate

made in USA

* IIC measures sound such as moving furniture and walking, STC measures sound such as voices and television. Minimum sound rating required by most building codes and architects is 50. R-Value is the rating used to measure resistance to heat flow. Δ Delta Rating is the only true measurement of sound reduction from a product (not a floor assembly) in the industry.

Enjoy the Advantages of Cork Plus



CORK PLUS

- Natural cork infused with 35% recycled EVA foam is more flexible and less prone to breakage than standard cork underlayment
- Quiets footfalls, as well as sound transfer from floor to living spaces below
- Helps prevent the transfer of stress cracks from the subfloor to flooring surface
- Ideal for use with radiant heat systems
- Use under ceramic tile, stone, marble, engineered wood and laminate floors
- Can be used in floating and glue-down floor installations



SKU	TEST	IIC RATING	STC RATING	DELTA RATING
72002 72019	w/6" cement slab & suspended ceiling	73	70	22



Visit us online for complete product offering

Using cork underlayment may contribute to satisfying credits under the LEED® Green Building Program

Discover the Benefits of Natural Cork



NATURAL CORK

- Quiets footfalls, as well as sound transfer from floor to living spaces below
- Helps prevent the transfer of stress cracks from the subfloor to flooring surface
- Ideal for use with radiant heat systems
- Use under ceramic tile, stone, marble, engineered wood and laminate floors
- Can be used in floating and glue-down floor installations



SKU	TEST	IIC RATING	STC RATING	DELTA RATING
72000Q 72003Q 72005Q 70-175	w/6" cement slab & suspended ceiling	74	70	22



CERTIFIED BY
SCS Global Services

Visit us online for complete product offering

Using cork underlayment may contribute to satisfying credits under the LEED® Green Building Program

MOISTURE BARRICADE

Moisture Barricade is designed for use with laminate and engineered wood flooring underlayments.

- 6-mil thick to stop moisture from reaching finished floors
- Provides the NWFA required moisture barrier over cement slabs
- Features an adhesive strip to lockout moisture
- Use with standard foam underlayment for added moisture protection
- Required for use with SPC flooring



Scan Here FOR PRODUCT INFO



Item No.	Description	Case Qty	Packaging
70-115	Moisture Barricade (120 sq. ft. Roll) 10' x 12' roll	12	Label
70-116	Moisture Barricade (300 sq. ft. Roll) 12' x 25' roll	6	Label

SILICONE MOISTURE BARRIER

Silicone Moisture Barrier meets the perm ratings recommendation by the National Wood Flooring Association for staples and nail-down installations of solid and engineered wood floors.

- For use over wood subfloors
- Reduces vapor flow without trapping moisture
- Helps reduce dust and noise levels
- Can be used with radiant heat systems—no asphalt odor



Scan Here FOR PRODUCT INFO



Item No.	Description	Case Qty	Packaging
70-198	Silicone Moisture Barrier (200 sq. ft. Roll) 33.5" x 72'	6	Label
70-198-XL	*CANADA ONLY Silicone Moisture Barrier (400 sq. ft. Roll) 31.5" x 152.5'	1	Corrugate

UNDERLAYMENT SEAM TAPE

Underlayment Seam Tape is ideal for joining underlayment seams under floating floors and for repairing rips during underlayment installation.

- PVC tape provides protection against moisture damage to floors
- Compatible with all brands of underlayment
- Multipurpose and versatile, tape can be used for carpet padding seams, sealing boxes and much more
- Ribbed for easier tearing



Item No.	Description	Case Qty	Packaging
50-040	Underlayment Seam Tape (1-7/8" x 100' Roll)	12	Printed Box

⚠️WARNING: Cancer and Reproductive Harm- www.P65Warnings.ca.gov. See P. 75. *Prop 65 - 1.

* IIC measures sound such as moving furniture and walking, STC measures sound such as voices and television. Minimum sound rating required by most building codes and architects is 50. R-Value is the rating used to measure resistance to heat flow. Δ Delta Rating is the only true measurement of sound reduction from a product (not a floor assembly) in the industry.

AQUABAR® "B" MOISTURE VAPOR BARRIER UNDERLAYMENT

Aquabar® "B" Underlayment is extremely effective in protecting against moisture damage. Recommended for use beneath wood flooring, ceramic, and stone veneer, or as a membrane on walls and countertops.

- Slows moisture migration, prevents flooring from buckling, cupping or cracking
- Acts as a slipsheet to minimize dust and reduce noise
- Smooth surface side makes planks easier to slide during installation
- Meets CA01350 indoor air quality standards



Item No.	Description	Case Qty	Packaging
70-195	Aquabar® "B" Moisture Vapor Barrier (500 sq. ft. roll) 36" x 167'	1	Polybag

WAXED PAPER ROLL UNDERLAYMENT

Waxed Paper Roll is recommended for the installation of hardwood and engineered nail-down flooring. Ideal for reducing squeaks in wood floors.

- Used as a barrier between wood subfloor and new floor on above grade installations
- Helps slides boards into place with ease



Item No.	Description	Case Qty	Packaging
70-120	Waxed Paper Roll (750 sq. ft. roll) 36" x 250'	1	Polybag

* **IIC** measures sound such as moving furniture and walking, **STC** measures sound such as voices and television. Minimum sound rating required by most building codes and architects is 50. **R-Value** is the rating used to measure resistance to heat flow. **Δ Delta Rating** is the only true measurement of sound reduction from a product (not a floor assembly) in the industry.



SPECIALTY TAPES

Quickly repair loose vinyl moldings, secure slipping carpets / rugs / treads, or complete household projects with our assortment of specialty tapes.

MAX GRIP® VINYL FLOOR INSTALLATION TAPE



For permanent installation of vinyl flooring, wall base, stair, tread and vinyl trim. Max Grip® Vinyl Flooring Installation Tape features an aggressive, acrylic adhesive for maximum holding power.

- Ideal for modified loose lay vinyl sheet flooring installation and flooring repairs
- Heavy-duty adhesive with reinforced scrim webbing instantly bonds with no clean-up required
- For indoor use, adheres to clean and dry subfloors



Item No.	Description	Case Qty	Packaging
50-540	Max Grip® Vinyl Flooring Installation Tape (1-7/8" x 50')	12	Printed Box

MAX GRIP® CARPET INSTALLATION TAPE



For the permanent installation of carpet, moldings and trim. Max Grip® Carpet Installation Tape features an aggressive acrylic adhesive for maximum holding power.

- Ideal for modified loose stair, treads and flooring repairs
- Heavy-duty adhesive with reinforced scrim webbing instantly bonds with no clean-up required
- For indoor and outdoor installations

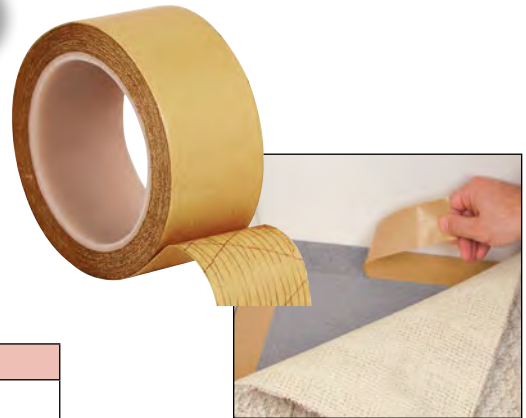

Item No.	Description	Case Qty	Packaging
50-550	Max Grip® Carpet Installation Tape (1-7/8" x 75')	12	Printed Box
50-560	Home Easy Carpet Installation Tape (1" x 164')	6	Individual Wrap / Corrugate
50-565	Max Grip® Carpet Installation Tape (3" x 164')	3	Individual Wrap / Corrugate

TREAD TAPE

Anti-slip safety strip, Tread Tape provides extra traction on stairs, loading docks and ladders. Coarse, grit sandpaper surface helps prevent slipping and falling.



Item No.	Description	Case Qty	Packaging
50-585	Tread Tape Roll (2" x 15')	6	Printed Box

DUCT TAPE

Duct Tape is ideal for HVAC duct work, temporary repairs, and household use. This is a general-purpose fabric-reinforced vinyl tape.

- Great for general repairs, projects, packing, seaming and sealing
- Pressure sensitive adhesive bonds quickly when pressed in place
- Easily tears by hand



Item No.	Description	Case Qty	Packaging
50-555	Duct Tape (1-7/8" x 60 yards)	36	Printed Box

RUG GRIPPER™ TAPE



Rug Gripper™ offers non-slip strength to keep your rugs and mats from bunching up or sliding across the floor on tile, marble, laminate, wood and carpet. This is an anti-slip tape for indoor use.

- Safe for all floor surfaces including carpet
- Removable and repositionable

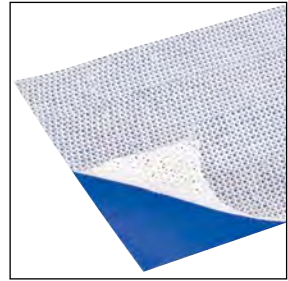

Item No.	Description	Case Qty	Packaging
50-580	Rug Gripper™ Tape Roll (2½" x 25')	6	Printed Box
50-588	Rug Gripper™ Tape Roll (3" x 60')	6	Printed Box

STAY 'N' PLACE® TAPE TABS

Featuring a unique dual adhesive technology, Stay 'N' Place® tabs prevent your rug corners from curling.

- Helps prevent rugs and mats (3' x 5') from moving and slipping
- Anti-skid tabs are safe to use on different hard floor surfaces
- Removable and repositionable



Item No.	Description	Case Qty	Packaging
50-547	Stay 'N' Place® Tabs 4-Pack (4" x 4")	24	Printed Sleeve

RUG TRACTION™ ANTI-SLIP RUBBER TAPE

Specifically designed with a non-slip strip for holding mats in place. Rug Traction™ Anti-Slip Rubber Tapes are easy to apply and require no clean up.

- Prevents slipping, curling and bunching, keeping rugs and mats looking neat and tidy
- Rubber composition and texture delivers great grip and top traction
- Can be cut to size, to provide better positioning and as much grip as needed



Item No.	Description	Case Qty	Packaging
50-545	Rug Traction™ Anti-Slip Rubber Tape (2½" x 25')	12	Printed Box



STICK WITH US FOR A SURE STEP.

For permanent installations of carpet / vinyl flooring, to safety tread for stairs, or a non-slip grip to hold your rugs and mats in place, ROBERTS® offers a tape that meets your flooring needs.



Scan here for
PRODUCT
INFORMATION



- For permanent installation of vinyl flooring, wall base, stair, tread and vinyl trim



Scan here for
PRODUCT
INFORMATION



- Provides extra traction on stairs, ramps, loading docks and ladders



Scan here for
PRODUCT
INFORMATION



- Offers non-slip strength to keep rugs and mats from bunching up or sliding across the floor



50-540
50-550
50-560
50-565



50-585



50-580
50-588



MERCHAN DISING

Increase profitability and generate more sales with numerous merchandising options. Tabletop / retail counter displays and in aisle / end cap displays allow you to feature adhesive cartridges and wood putty repair SKUS. Rugged, 4' gondola showcases top-selling tool assortment or can be customized to suit your merchandising needs.

4' CARPET, VINYL & LAMINATE TOOL MERCHANDISING DISPLAY

FREE display with the purchase of top selling tools.

- Designed and merchandised to deliver incremental sales at high margins
- Included header is adjustable and measures 48" wide x 10" tall
- Display measures 48" wide x 26" deep x 72" high



**\$500
VALUE**

FLOORING PUTTY COUNTERTOP DISPLAY

FREE display with the purchase of top selling tools.

- Included header measures 8½" wide 3½" tall
- Display measures 8½" wide x 10-1/32" deep and 20-1/8" high



**\$70
VALUE**

Item# CTDPUTTYRACK
Sign# CTDPUTTYSIGN

FLOORING PUTTY IN-AISLE DISPLAY

FREE display with the purchase of top selling tools.

- Included headers measures 2" wide x .062" tall
- Display measures 2" wide 2" deep and 27" high



**\$80
VALUE**

Item# 3TRPUTTYRACK
Sign# 3TRPUTTYSIGN

See your sales rep for more details!

10 OZ. ADHESIVE CARTRIDGE COUNTERTOP DISPLAY

FREE display with the purchase of top selling tools.

- Included header measures 11.596" wide 3-1/8" tall
- Display measures 11.596" wide 16.750" deep and 8.858" high



**\$76
VALUE**

Item# CTD12X9,100Z
Sign# CTD12X9SIGN

10 OZ. ADHESIVE CARTRIDGE IN-AISLE DISPLAY

FREE display with the purchase of top selling tools.

- Included header measures 5" wide x 3½" tall
- Display measures 5" wide x 5" deep and 41" high



**\$96
VALUE**

Item# 3TB41X5, 100Z
Sign# 3TB41X5SIGN

30 OZ. ADHESIVE CARTRIDGE COUNTERTOP DISPLAY

FREE display with the purchase of top selling tools.

- Included header measures 5.88" wide 3-1/8" tall
- Display measures 5.88" wide 7.16" deep and 56.77" high



**\$92
VALUE**

Item# CTD16X9,300Z
Sign# CTD16X9SIGN

30 OZ. ADHESIVE CARTRIDGE IN-AISLE DISPLAY

FREE display with the purchase of top selling tools.

- Included header measures 6" wide 5½" tall
- Display measures 6" wide x 6" deep and 56" high



**\$85
VALUE**

Item# 3TB56X6, 300Z
Sign# 3TB56X6SIGN

FLOOR DISPLAYS

Corrugated floor displays are available. See your sales rep for options.



See your sales rep for more details!

ICON LEGEND



Based on sales over the last 12 months



This product includes a 1 year warranty which must be registered online at robertsconsolidated.com



A patent has been filed for this product's design or parts



This product is backed by a limited-lifetime warranty, provided it was installed by a qualified installer following manufacturer installation instructions and requirements



This SKU features multiple products



This product features a custom carry case



This product features components that can be adjusted



Uses carpet blades



Uses utility blades



Uses hooked blades



Uses hawk blades



Provides straight cuts on planks



Provides diagonal cuts on planks



Replacement parts available

INDEX By Item Number

Item #	Description	Page
10-018	The Maverick™ Wide Angle Pull Bar	45
10-10	Carpet Puller	17
10-18-8	Pro Pull Bar	45
10-25	Universal Tapping Block	44
10-26	Flooring Installation Kit (30 Wedge Spacers)	43
10-27	Expansion Joint Wedge Spacers	43
10-28	Flooring Installation Kit (50 Wedge Spacers)	43
10-33	Universal Repair Kit	51
10-35	8" Laminate & Vinyl Plank Cutter	42
10-36	Dual Expansion Joint Spacers	43
10-42	4¼" 20-Tooth Carbide-Tipped Saw Blade	28
10-43	Pro Flooring Installation Kit	43
10-46	Super Six 6" Jamb Saw	28
10-47-2	6-3/16" 36-Tooth Carbide-Tipped Saw Blade	27, 28
10-47-6	6-3/16" 20-Tooth Carbide-Tipped Saw Blade	27, 28
10-49	Double Tap™ Reversible Tapping Block	44
10-55-24	6" Durable Masonry Blade	27, 28
10-56	Longneck Plus 6" Jamb Saw	27
10-60	9" Multi-Floor Cutter	41
10-63	13" Multi-Floor Cutter	41
10-91	9" Multi-Floor Cutter	40
10-99	18" Multi-Floor Cutter	40
10-100	5" Carpet Seam roller	31
10-101	4.5" Deluxe Carpet Seam Roller	17
10-107-03	Replacement: Tail Blade Unit	9
10-108	Professional 2" Strip Cutter	30
10-109	Staple Hammer	14, 18
10-114	20-oz. Ripping Hammer	18, 48
10-117-04	Replacement: Power Head Unit	9
10-121	8" Napping Shears	22
10-122	6" Pro Loop Pile Carpet Seam Roller	16
10-123	10" Carpet Shears	22
10-124	6" Pro Cut Pile Carpet Seam Roller	16
10-128	Locking Pattern Matching & Seam Repair Stretcher	9
10-140	30' Tape Measure	18, 50
10-146-3	Cushion Back Carpet Cutter	21
10-146GT	Golden Touch Cushion Back Carpet Cutter	18, 21
10-151	Nail Driving Bar	18, 31
10-152-3	Loop Pile Cutter	21
10-152GT	Golden Touch Loop Pile Cutters	18, 21
10-154-3	Universal Seam Cutter	22
10-163	24" Steel Tool Box	18
10-169	4" Star Wheel Pro Carpet Seam Roller	17, 18
10-170	4" Cut Pile Seam Roller	16
10-181	Dual Notch Economy Trowel	54
10-188	Pro 4" Floor & Wall Scraper	48
10-194	4" Floor and Wall Scraper & Stripper (12" Handle)	49
10-195	Heavy-Duty 6" Convertible Scraper	49
10-195-01	Replacement: 6" Hardened Steel Blade	49
10-215	Razor Blade Knife	24
10-216	3-IN-1 Carpet, Vinyl & Utility Knife	23
10-218F	Big Fatso Multipurpose Knife	24
10-220	Cut & Jamb Carpet Knife	24
10-221	Pro Utility Knife	25
10-230-10	3' Steel Stretcher Tube	8
10-230-3K	Tube Case with Three 3' Extension Tubes	8
10-230-40	Empty Stretcher Case with Wheels	8
10-235-05	5' Aluminum Stretcher Tube	8
10-235-10	3' Aluminum Stretcher Tube	8

Item #	Description	Page
10-237	Junior Power Carpet Stretcher Standard Kit	7
10-237V	Junior Power Carpet Stretcher Value Kit	7
10-237-50	Replacement: Stretcher Head	7
10-248	Nap Grip Head	8
10-250	Adjustable Locking Tube	8
10-252	Professional Carpet Knife	18, 23
10-253	Slotted Blade Carpet Knife	24
10-254	Power-Lok® Carpet Stretcher Standard Kit	7
10-254V	Power-Lok® Carpet Stretcher Value Kit	7
10-254-50	Replacement: Stretcher Head	7
10-258	Power Stretcher Tail	8
10-259	Pro Dual-Depth Carpet Knife	23
10-260	Deluxe Grip Pouch	18, 50
10-279	Topset Gouge	34
10-282G-2	Deluxe Heat Bond Iron	13
10-286G	6" Heat Bond Seaming Iron	13
10-294	4" Floor and Wall Scraper & Stripper (18" Handle)	49
10-296	Stand-Up Scraper	49
10-303S	Chalk Reel	18, 50
10-321	Replacement: White Chalk Refill	18, 50
10-404	5-Pack Hawk Utility Blades	26
10-410	Adjustable Knee Kicker	12
10-412BKK	Deluxe Knee Kicker Black	11
10-412-09	Replacement: Bumper Pad (2" thick)	12
10-412-2	Deluxe Knee Kicker (Silver)	11, 18
10-422-09	Replacement: Bumper Pad (3" thick)	12
10-422BK	Deluxe High-Profile Knee Kicker	11
10-439	6 Strip Cutter Blades Blister Cards	30
10-440	Hooked Blades	26
10-442-10	Replacement: 4" Floor & Wall Scraper Blade	49
10-458	Replacement: 8" Floor & Wall Scraper Blade	49
10-460	Replacement: 9" Blades for 10-60	41, 42
10-463	Replacement: 13" Blades for 10-63	41, 42
10-468	Replacement: 25" Blades for 10-95	40, 42
10-480	Dual Air Glider	47
10-482G	Cool Shield® Heat Bond Iron	13
10-501	Golden Touch® Carpet Knee Kicker	11
10-503	Pro Mini Pry Bar	18, 48
10-517	Row Finder & Separator	18
10-521	Pro Stair Tool	18, 19
10-522-4	EZ TUK Carpet Tucker	18, 19
10-575	Heavy Cargo Dollies (Set of 2)	47
10-585	6" Duckbill Napping Shears	22
10-586-3	7" Duckbill Napping Shears	18, 22
10-600	Professional Electric Stapler	14
10-616-2A	Conventional Carpet Trimmer	18, 21
10-617GT	Golden Touch® Carpet Trimmer	21
10-750	Deluxe Carpet Installation Kit	18
10-810	1/16" x 1/16" x 1/16" SQ-Notch Wood Handle Trowel	54
10-816	1/16" x 1/16" x 1/32" U-Notch Wood Handle Trowel	54
10-820	3/32" x 3/32" x 3/32" Flat-Top V-Notch Wood Handle Trowel	54
10-823	1/16" x 1/16" x 1/16" SQ-Notch Comfort Grip Trowel	54
10-829	1/16" x 1/32" x 1/32" U-Notch Comfort Grip Trowel	54
10-833	3/32" x 3/32" x 3/32" V-Notch Comfort Grip Trowel	54
10-895	12" Vinyl Tile Cutter	33
10-900	12" Pro Vinyl Tile Cutter	33
10-905	Multipurpose Wall Trimmer	21
10-910	Replacement: 9" Blades for 10-91	39, 40

Item #	Description	Page
10-911	9" PrecisionCuts™ Pro Multi-Floor Cutter	39
10-918	18" Pro Vinyl Tile Cutter	33
10-920-6	Pro Fixed-Blade Knife	18, 25
10-925	Pro Vinyl Flooring Knife	25
10-931	Vinyl Flooring Knife	18, 26
10-935	35 lb. Vinyl & Linoleum Flooring Roller	34
10-940	Replacement: 13" Tungsten Carbide Blade	40, 42
10-942	13" PrecisionCuts™ Pro Multi-Floor Cutter	39
10-950	75 lbs. Heavy-Duty Flooring Roller	15
10-952	100 lbs. Heavy-Duty Flooring Roller	15
10-952-04	Replacement: Transport Wheel Assembly Kit	15, 34
10-955	Extendible Floor Roller	35
10-959	25" PrecisionCuts™ Pro Multi-Floor Cutter	38
10-964	Vinyl Seam Roller	34
10-975	Power-Lok® Extendible Flooring Roller	35
10-981-25	Snuzzle Adhesive Applicator	54
10-981	Snuzzle Adhesive Applicator (Canada Only)	54
10-990	Replacement: 18" Tungsten Carbide Blade	40, 42
10-997	18" PrecisionCuts™ Pro Multi-Floor Cutter	38
10-1600	Mozart Weld Rod Trimmer (Canada Only)	50
10-2100	The General™ Knee Kicker	10
10-5418D	9/16" Staples (5000 / box)	14
10-8678	Replacement: Mozart Trimmer Blades (5 Pack Card)	50
10-8679	Replacement: Mozart Trimmer Scraper Claw (0.5 mm)	50
10-8700	Replacement: Mozart Trimmer Scraper Claw (0.7 mm)	50
20-1450	Smooth Edge Peel & Stick Carpet Tack Strip (3-pk)	30
30-110	3/8" Chisel Point Staples (5000/box)	14
30-210	3/8" Divergent Point Staples (5000/box)	14
33-100	5/8" Concrete Nails (1 lb. bag)	37
50-040	Underlayment Seam Tape	62
50-540	Max Grip® Vinyl Flooring Installation Tape	65
50-545	Rug Traction™ Anti-Slip Rubber Tape	66
50-547	Stay 'N' Place® Tabs 4-Pack	66
50-550	Max Grip® Carpet Installation Tape (1-7/8" x 75')	65
50-555	Duct Tape (1-7/8" x 60 yards)	65
50-560	Max Grip® Carpet Installation Tape (1" x 164')	65
50-565	Max Grip® Carpet Installation Tape (3" x 164')	65
50-580	Rug Gripper Tape Roll (2½" x 25')	66
50-585	Tread Tape Roll (2" x 15')	65
50-588	Rug Gripper Tape Roll (3" x 60')	66
70-010	Serenity Foam Underlayment (100 sq. ft. roll)	59
70-010-XL	Serenity Foam Underlayment (400 sq. ft. roll)	59
70-025	Unison® 2-in-1 Underlayment	59
70-026	Black Jack® Underlayment (100 sq. ft. roll)	58
70-026-XL	Black Jack® Underlayment (600 sq. ft. roll)	58
70-102-1	First Step® Premium (630 sq. ft. roll)	57
70-102-12	First Step® Premium (100 sq. ft. roll)	57
70-115	Moisture Barricade (120 sq. ft. roll)	62
70-116	Moisture Barricade (300 sq. ft. roll)	62
70-120	Waxed Paper Roll	63
70-127-3	Carpet Rake & Groomer	19
70-175	Natural Cork Sheet (50-pk)	60
70-180	Quiet Cushion® Underlayment	57
70-185	Soft Stride® Underlayment	59

Item #	Description	Page
70-190	Super Felt® Underlayment (100 sq. ft. roll)	58
70-193	Super Felt® Underlayment (360 sq. ft. roll)	58
70-195	Aquabar® "B" Moisture Vapor Barrier	63
70-197	Sound Barricade Underlayment	58
70-198	Silicone Moisture Barrier (200 sq. ft. Roll)	62
70-198-XL	Silicone Moisture Barrier (400 sq. ft. Roll) (Canada Only)	62
10113 (QEP)	1/4" x 1/4" x 1/4" SQ-Notch Economy Trowel	54
10137-12	1/8" X 1/16" Flat-Top V-Notch Economy Trowel	54
30002	Quik-Cut Vinyl Tile Cutter	34
49713 (QEP)	1/4" x 1/4" x 1/4" SQ-Notch Wood Handle Trowel	54
49730	3/16" X 1/4" X 1/2" Flat-Top V-Notch Wood Handle Trowel	54
49737	1/8" x 1/8" x 1/16" Flat-Top V-Notch Wood Handle Trowel	54

Item #	Description	Page
49738	1/16" x 1/32" x 5/64" U-Notch Wood Handle Trowel	54
49766	1/8" x 1/8" x 1/8" SQ-Notch Wood Handle Trowel	54
49767	1/4" x 3/16" Tiger Tooth Wood Handle Trowel	54
49768	1/16" x 1/16" x 1/16" SQ-Notch Wood Handle Trowel	54
49769	1/4" x 1/4" 1/4" Flat-Top V-Notch Wood Handle Trowel	54
49915 (QEP)	1/4" x 1/4" x 1/4" SQ-Notch Comfort Grip Trowel	54
49771	1/16" x 1/16" x 1/16" SQ-Notch Wood Handle Trowel	54
61613	White Rubber Mallet	18
72000Q	Natural Cork (200 sq. ft. Roll)	60
720002	Cork Plus (200 sq. ft. Roll)	61
72003Q	Natural Cork (100 sq. ft. Roll)	60
72005Q	Natural Cork Sheets (50-pk)	60
72019	Cork Plus Sheets (5-pk)	61

Item #	Description	Page
72019-25	Cork Plus Sheets (25-pk)	61
79023-6	Hard Cap Knee Pads	47
79034	Pro Carpet Knee Pads	47
PC7725	Brown Repair Putty	51
PC2226	Light Repair Putty	51
PC7728	Grey Repair Putty	51
PC7730	Tan Repair Putty	51
PC7732	Dark Brown Repair Putty	51
PC7733	Light Grey Repair Putty	51

QUALITY, PERFORMANCE & PRECISION AT EVERY STAGE

Discover best-in-class product solutions developed by our world class manufacturing partners



AFFILIATES



ROBERTS® WARRANTY

All ROBERTS® include a manufacturer's limited warranty ensuring the product is free from defects in materials and workmanship for a period of one-year from the date of purchase. This warranty does not cover accidental damages, unreasonable or improper use, normal wear and tear, loss of use, or consequential damages. Some items, such as carpet stretchers, kickers, cutters, cargo dollies and dual air glider carry a ROBERTS® 1-Year Limited Warranty. Product registration, included with the product packaging, must be completed within 30 days of purchase for eligibility. This warranty covers refund or replacement due to a defect in materials or workmanship for a term of one year. Visit robertsconsolidated.com/warranty to register your product.

ABOUT CALIFORNIA PROPOSITION 65

Proposition 65 is a California regulatory law that requires businesses to notify California consumers about specific chemicals in the products they purchase so they can make informed decisions about protecting themselves from exposure to these chemicals. This law requires companies to properly label products that contain chemical(s) above certain threshold levels.

As part of Q.E.P. Co. Inc.'s continued best business practice and compliance program, we comply with Proposition 65 warning requirements and provide product-associated warnings. We are dedicated to meeting consumer product safety requirements applicable to our products and strive to provide high quality and safe products.

For more information on California Proposition 65, go to www.P65Warnings.ca.gov.

- *Prop 65 - 1. **⚠️WARNING:** This product can expose you to chemicals including DEHP, which is known to the State of California to cause cancer, birth defects and other reproductive harm.
- *Prop 65 - 2. **⚠️WARNING:** This product can expose you to chemicals including Lead, which is known to the State of California to cause cancer, birth defects and other reproductive harm.
- *Prop 65 - 3. **⚠️WARNING:** This product can expose you to chemicals including Nickel (Metallic), which is known to the State of California to cause cancer.
- *Prop 65 - 4. **⚠️WARNING:** This product can expose you to chemicals including Lead and DEHP which is known to the State of California to cause cancer, birth defects or other reproductive harm.
- *Prop 65 - 5. **⚠️WARNING:** This product can expose you to chemicals including Quartz and Styrene, which are known to the State of California to cause cancer and Methanol, which is known to the State of California to cause birth defects or other reproductive harm.
- *Prop 65 - 6. **⚠️WARNING:** This product can expose you to chemicals including Silicia (crystalline, respirable) and Diisodecyl Phthalates which are known to the state of California to cause cancer, and birth defects or other reproductive harm.

The products, specifications, and Prop 65 Warnings listed in this catalog are current as of the printed date of this catalog and are subject to change. Access product data sheets, technical bulletins, warranties and SDS documents 24 hours a day, 7 days a week through our continuously updated website.

TRADEMARKS

ROBERTS®, Black Jack Floating Floor Underlayment®, Cool Shield®, the e® logo, First Step®, GoldGuard®, Golden Touch®, Max Complete®, Max Grip®, Power-Lok®, Quiet Cushion®, Soft Stride®, Super Felt®, Tiger Tooth®, and Unison® are registered trademarks of Roberts Consolidated Industries, Inc.

Double-Tap™, The General™ and The Maverick™ are trademarks of Roberts Consolidated Industries, Inc.

Aquabar® "B" is a registered trademark of Fortifiber, LLC.

Microban® is a registered trademark of Microban Products Company.

Rug Gripper™ is a trademark of Optimum Technologies, Inc.

CRI™ is a trademark of The Carpet and Rug Institute

2024 FLOORING TOOLS & UNDERLAYMENT

Products on cover:

The General™ Knee Kicker (10-2100), Pro Carpet
Knee Pads (79034), Deluxe Grip Pouch (10-260)

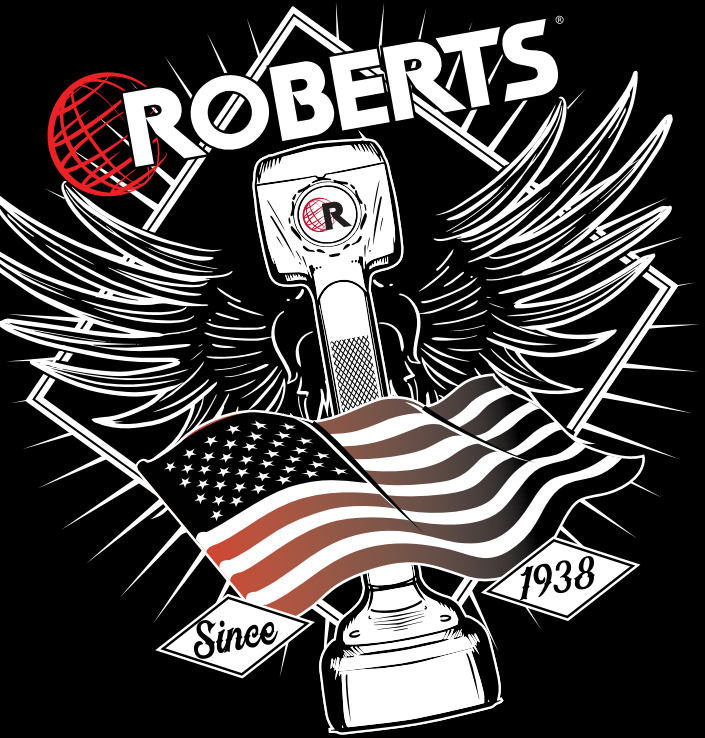

1001 Broken Sound Parkway, NW
Boca Raton, Florida 33487

For more information call 866-435-8665
Se habla español



robertsconsolidated.com

Scan here
for the latest



ROBERTS®
TOOL CATALOG

Scan here
for the latest



ROBERTS®
ADHESIVE CATALOG



E2624-12251
ROBT00L2024