



2025 FLOORING TOOLS & UNDERLAYMENTS



ROBERTS® KEY MILESTONES

- 1938:** Company founded
- 1938:** Introduced Smoothedge Carpet Gripper
- 1939:** Introduced Rub-er-ege Latex Carpet Adhesive
- 1949:** Filed Carpet Stretching Device patent
(*Today's Kicker*)
- 1959:** Filed trademark for Anchor-Weld
- 1963:** Incorporated
- 1968:** Filed Loop Pile Carpet Cutter patent
- 1968:** Filed Cushion Back Carpet Cutter patent
- 1968:** Filed patent for Carpet Trimmer
(*Today's Wall Trimmer*)
- 1975:** Filed Carpet Adhesive Seaming Iron patent
(*Today's Deluxe Heat Bond Iron*)
- 1981:** Hot-Melt Carpet Seaming Tape was introduced and marketed worldwide
- 1987:** Became one of the first to market with solvent-free adhesives
- 1988:** Filed Carpet Stretcher patent
(*Today's Power-Lok® and Junior Power Stretcher*)
- 1994:** Filed Heat Seaming Iron patent (*Today's Cool Shield Heat-Bond Seaming Iron*)
- 1997:** QEP Co., Inc. acquired Roberts Consolidated Industries, Inc.
- 1998:** Filed Jamb Saw patent
- 2001:** Filed Carpet Knife patent
(*Today's Cut & Jam Knife*)
- 2005:** Launched AirGuard® Premium Underlayment
- 2017:** Filed Flooring Spacer patent
(*Today's Dual Expansion Flooring Spacer*)
- 2019:** Launched Universal+ Adhesives with Advanced Moisture Technology
- 2021:** Filed 4-in-1 Flooring Expansion Spacer patent
- 2023:** Filed patents on 7 new flooring tools
- 2024:** Introduced partnership with Microban® as exclusive North American adhesive provider of superior mold and mildew protection
- 2024:** Introduced FloorScore Certification
- 2025:** Introduced Falcon™ Power 44 Stretcher and PowerTak™ Electric Tacker



The quintessential American dream, ROBERTS® began with a shared vision - a vision for working smarter not harder - to more quickly and efficiently install wall-to-wall carpet. Pooling a modest sum of \$3,000 to invest in plywood, a table saw, shingle nails, pliers and a few other essentials, Roy Roberts, Hugh Livie and Ken Bishop travelled the countryside selling and training installers to use tackless carpet strips.

Decades later, with countless patents and hundreds of products available worldwide, ROBERTS continues to be recognized as the world's authority on flooring installation tools, adhesives and underlayments, earning the respect and trust of generations of carpet installers.

We take great pride in the quality and dependability of our ROBERTS products, and are committed to the evolution of these offerings to meet the needs and challenges of today's professional installers.

A Brand You Can Trust.

An iconic brand with an established market in more than 100 countries, ROBERTS capitalizes on decades of experience in the industry, fosters true partnerships with national trade affiliates and training certification partners, and is committed to exceeding your expectations - one product at a time.

- **Award-winning, multilingual Customer Service Team**
- **Expert-level technical support to receive and resolve your product and industry questions**
- **Research & Development Team dedicated to improving, advancing, enhancing, and innovating our products through best of class findings from across the globe**
- **Partnership with industry affiliates including the International Certified Flooring Installers Association, the Floor Covering Education Foundation, and the Wood Floor Covering Association among others, to support and invest in the trade**
- **600K ft² of warehouse and manufacturing space to ensure job-lot quantities and availability of replacement parts**

ROBERTS® On-Going Commitment to Sustainability

We routinely challenge ourselves to reimagine the design, packaging and construction of our products with materials that are recycled, biodegradable or otherwise earth friendly. Our most recent eco-friendly / sustainability efforts include the following:

- **Removed single-use plastic from more than 210 items**
- **Replaced tens of thousands of lbs of virgin plastic with recycled plastic**
- **Eliminated 95,000+ lbs of plastic from our packaging**

Se habla español | français parlé

THE ROBERTS CO.



Supporting Professional Installers
- Since 1938 -

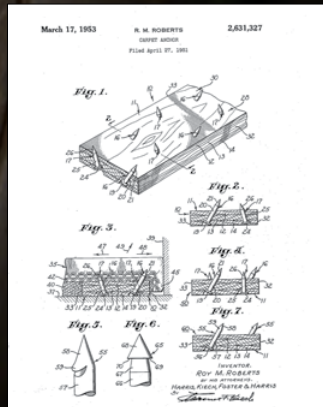
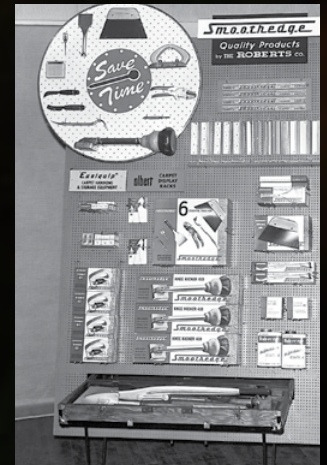
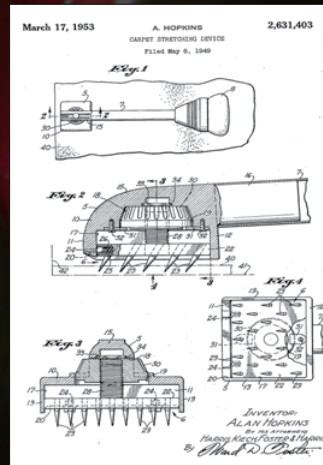
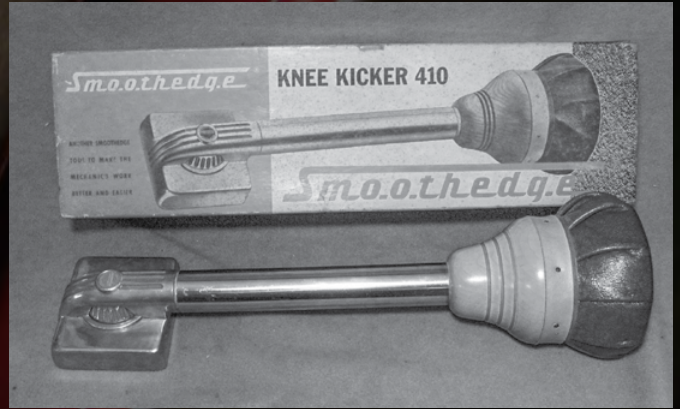



UNPARALLELED COMMITMENT TO QUALITY, PERFORMANCE, AND PARTNERSHIP

At ROBERTS, success isn't solely measured in profits and price points. It is measured in the reliability of our tools, the satisfaction of our customers, and the trust placed in the brand by the professional installers and customers that use them.

QUALITY

WORLD-CLASS MANUFACTURING & INNOVATION

In pursuing this success, we have invested in building relationships with some of the world's foremost experts in industrial design, manufacturing, and tooling. Rigorous quality-assurance measures have been put in place to ensure every product that carries our brand exceeds the expectation of our customers.

PERFORMANCE

SATISFACTION GUARANTEED

At ROBERTS, customer satisfaction is paramount, which is why we offer a 'best in class' warranty program. In doing so most of our tools, underlayments, and accessories carry a limited-lifetime warranty, two-year warranty, or a one-year warranty. Visit us online at robertsconsolidated.com for individual warranty terms and details.

PARTNERSHIP

INVESTING IN OTHERS

Success does not happen by accident. At ROBERTS, success has been the result of working with passionate, like-minded people that share our commitments and goals. In partnering with installers, trade affiliates and certification partners, we not only ensure that we're developing products that meet the needs of generations of installers, we are investing in the future of the trade itself.

AFFILIATES:

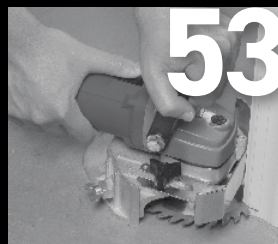

TABLE OF CONTENTS



7

CARPET TOOLS
CARPET STRETCHERS, HEAT-BOND IRONS, KNEE KICKERS, ROLLERS & HAND TOOLS



53

UNIVERSAL TOOLS
STAPLER, DOLLIES, GLIDER, SCRAPER, PRY BAR, HAMMER & HAND TOOLS

CUTTING TOOLS
CARPET CUTTERS, TRIMMERS, SHEARS, KNIVES & JAMB SAW



25



TROWELS
CARPET, VINYL & WOOD

62



36

TACK STRIP
TACK STRIP, CUTTERS, NAILS & NAIL DRIVING BAR



65

UNDERLAYMENTS
LAMINATE, WOOD, LVT, VINYL & CORK



72

SPECIALTY TAPES
INSTALLATION, RUG GRIPPER & STAY 'N' PLACE TABS



39

VINYL TOOLS
VINYL CUTTERS, ROLLERS & HAND TOOLS



43

LVP, LAMINATE & WOOD TOOLS
FLOOR CUTTERS, INSTALLATION KITS, PUTTY, NAILS & HAND TOOLS

MERCHANDISING
GONDOLA, DUMP DISPLAYS, GRAVITY-FED-RACKS & COUNTERTOP DISPLAYS



75

ROBERTS



CARPET TOOLS

Developed with the professional installer in mind, our carpet tools are the culmination of 87 years of precision, performance and patents. From our Falcon Power 44™ Stretcher, Power-Lok and Locking Pattern Matching Seam Repair Stretchers to The General® Knee Kicker, Cool Shield® Heat Bond Seaming Iron, PowerTak™ Electric Tacker, and everything in between, you can expect quality and satisfaction from all of our carpet tools.

NEW
AVAILABLE
FALL '25

FALCON™

— POWER 44 STRETCHER —

The Falcon is the only power stretcher with a 44" tailblock to span doorways.



- Patent-pending tailblock features tool-free, quick-release extensions to allow a stretch across a doorjamb
- Metal cover plate with incorporated handle makes gripping and repositioning the stretcher head easier
- Installer-preferred, low-profile handle with soft grip built into the head for comfortable, extended use
- Low-profile head with side-kicking platform for use with knee kicker
- Stretch up to 38' (with the value kit) and up to 23½' (with the standard kit)
- Adjustable pin penetration for different carpet thicknesses
- Swivel head locks into 5 different stretch / pattern-holding positions

The Falcon Power 44 Stretcher standard kit includes a power unit, tail block with wheels, three 3' extension tubes, adjustable locking tube, transfer tube and the wheeled-stretcher carrying case. The Falcon Power 44 Stretcher value kit includes everything in the standard kit PLUS three additional 3' tubes, and the tube carrying case which interlocks with the wheeled stretcher case.

**WIDEST
TAILBLOCK
IN THE
INDUSTRY**

UP TO 44"

Item No.	Description	Case Qty	Packaging
10-284	Falcon Power 44 Stretcher Standard Kit	1	Carrying Case
10-284V	Falcon Power 44 Stretcher Value Kit	1	Carrying Case
10-284-50	Replacement: Falcon Power 44 Stretcher Head	1	Carton
10-242	Accessory: Falcon Power 44 Nap Grip Head	1	Carton



Carpet tucking and cutting is made easy with the use of the pattern-holding positions.



**LOW-PROFILE HEAD
WITH SIDE KICKING PLATFORM
FOR USE WITH KNEE KICKER**



**THE ONLY TAILBLOCK
TO SPAN DOORWAYS**

**WIDEST
TAILBLOCK
IN THE
INDUSTRY**

UP TO 44"

POWER-LOK STRETCHER

The Power-Lok Stretcher is the most advanced power stretcher available.



10-254V

- Swivel head locks into 5 different stretch / pattern-holding positions
- Adjustable pin penetration for different carpet thicknesses
- Non-marring tail block prevents damage to finished walls while stretching
- Low-profile head with side-kicking platform for use with knee kicker
- Stretch up to 38' (with the value kit) and up to 23½' (with the standard kit)

The Power-Lok Stretcher standard kit includes a power unit, tail block with wheels, three 3' extension tubes, adjustable locking tube, transfer tube and the wheeled-stretcher carrying case. The Power-Lok Stretcher value kit includes everything in the standard kit PLUS three additional 3' tubes, and the tube carrying case which interlocks with the wheeled stretcher case.

Item No.	Description	Case Qty	Packaging
10-254	Power-Lok Carpet Stretcher Standard Kit	1	Carrying Case
10-254V	Power-Lok Carpet Stretcher Value Kit	1	Carrying Case
10-254-50	Replacement: Stretcher Head	1	Carton
10-248	Accessory: Nap Grip Head	1	Carton



JUNIOR POWER STRETCHER

The Junior Power Stretcher is our most economical power stretcher and ideal for professional installers.



10-237V

- Locking handle ensures proper stretch
- Low-profile power head is easy to span with a knee kicker
- 18" spring-loaded tail block with wheels provides additional support
- Stretches over 38' (with the value kit) and up to 23½' (with the standard kit)

The Junior Power Stretcher standard kit includes a power unit, tail block with wheels, three 3' extension tubes, adjustable locking tube, transfer tube and wheeled-stretcher carrying case. The Junior Power Carpet Stretcher value kit includes everything in the standard kit PLUS three additional 3' tubes, and the tube carrying case which interlocks with the wheeled stretcher case.

Item No.	Description	Case Qty	Packaging
10-237	Junior Power Stretcher Standard Kit	1	Carrying Case
10-237V	Junior Power Stretcher Value Kit	1	Carrying Case
10-237-50	Replacement: Stretcher Head	1	Carton
10-248	Accessory: Nap Grip Head	1	Carton



ADDITIONAL STRETCHER TUBES



Engineered for superior performance and durability, and designed to fit all ROBERTS® and standard stretchers.

Item No.	Description	Case Qty	Packaging
10-250	Adjustable Stretcher Locking Tube	1	Carton
10-230-10	3' Steel Stretcher Extension Tube (for use with 10-284, 10-284V, 10-254, 10-254V, 10-237 and 10-237V stretchers)	1	Carton
10-235-10	3' Aluminum Stretcher Tube (not shown)	1	Carton
10-235-05	5' Aluminum Stretcher Tube (not shown)	1	Carton

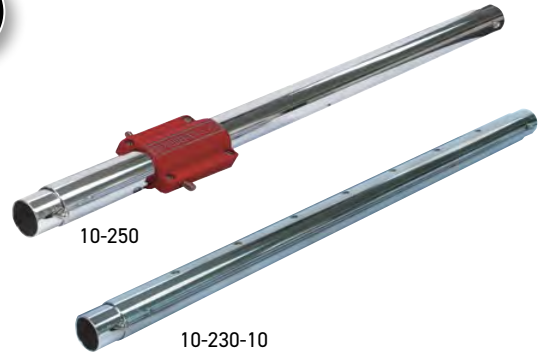

STRETCHER CASE SYSTEM



ROBERTS® Stretcher Case System includes a stretcher case with wheels, and a tube case that interlocks to the stretcher case for easy transport.

- Comfort-grip handle and 4" wheels for easier transport
- Recessed hinges and latches to prevent breakage
- High-density, blow-molded plastic walls for added durability
- Nylon web belt with quick-release buckle to secure the cases together

The stretcher case can accommodate a ROBERTS® Falcon Power 44, Power-Lok or Junior Power stretcher unit, tail block with wheels, three 3' extension tubes, adjustable locking tube and transfer tube.

Item No.	Description	Case Qty	Packaging
10-284-40	Empty Falcon Power 44 Stretcher Case with Wheels (for use with 10-284 and 10-284V)	1	Carton
10-230-40	Empty Stretcher Case with Wheels (for use with 10-254, 10-254V, 10-237 and 10-237 V stretchers)	1	Carton
10-230-3K	Tube Case with Three 3' Extension Tubes	1	Carton



NAP GRIP HEAD (COTTON HEAD)



Designed for use on low-profile loop, cut pile and woven carpets, Nap Grip Head. It is compatible with both the Falcon Power 44, Power-Lok and Junior Power Carpet Stretchers.

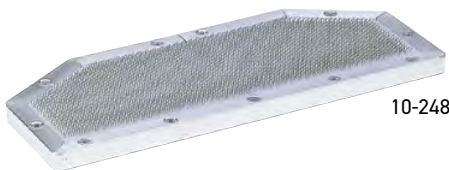

10-248

Item No.	Description	Case Qty	Packaging
10-242	Falcon Power 44 Nap Grip Head (for use with 10-284 and 10-284V)	1	Carton
10-248	Nap Grip Head (for use with 10-254, 10-254V, 10-237 and 10-237V)	1	Carton

POWER STRETCHER TAIL



Designed to fit ROBERTS® stretchers, the Power Stretcher Tail pierces through carpet and pad into wood for a firm, solid stretch, even when there are no walls to brace against.



Item No.	Description	Case Qty	Packaging
10-258	Power Stretcher Tail (for use with 10-254, 10-254V, 10-237 and 10-237V)	1	Carton

LOCKING PATTERN MATCHING & SEAM REPAIR STRETCHER

Designed to quickly and accurately match patterns during carpet installation and repair.



- ON/OFF locking mechanism locks the powerhead at 1/4" movement of the pinplate, ensuring precise pattern alignment
- Dual powerhead configuration for correcting bowing, skewing, and misaligned patterns, as well as compressing gapped seams
- Adjustable pin depths to accommodate different carpet thicknesses
- Die-cast frame holds up to 300 lbs. of stretch tension
- Includes custom-molded carrying case



Item No.	Description	Case Qty	Packaging
10-128	Locking Pattern Matching & Seam Repair Stretcher	1	Carrying Case
10-117-04	Replacement: Power Head Unit	1	Carton
10-107-03	Replacement: Tail Blade Unit	1	Carton

Scan Here
FOR PRODUCT INFO



⚠WARNING: Cancer and Reproductive Harm - www.P65Warnings.ca.gov. See P. 81, *Prop 65 - 1.

The GENERAL[®] KNEE KICKER

The General[®] features an extra-wide 5" head, four nap grip strips and five rows of steel pins to maneuver carpet with ease and precision.



- 25% wider head for improved load distribution
- Gel bumper is mounted at a 5° angle to maximize kicks while reducing knee shock
- High-contour neck for use over stretcher head and poles
- Easy adjustments from 17½" to 21½"
- Center grooved head for adjusting power stretcher head
- Die-cast aluminum body for maximum strength and durability



Gel bumper is mounted at a 5° angle to maximize kicks while reducing knee shock

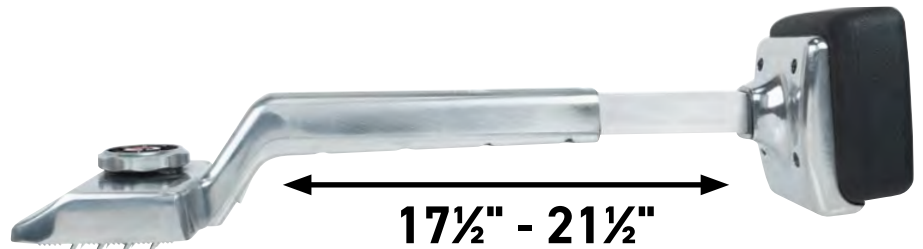

Scan Here FOR PRODUCT INFO



Item No.	Description	Case Qty	Packaging
10-2100	The General [®] Knee Kicker	3	Printed Carton

GOLDEN TOUCH® CARPET KNEE KICKER



The ROBERTS signature kicker, Golden Touch® Carpet Knee Kicker provides the greatest length adjustment for repairing and/or stretching loose carpet.

- Trigger release adjusts from 18-7/8" to 24"
- Foam bumper is mounted at a 5° angle to maximize kicks while reducing knee shock
- High-contour neck for use over stretcher head and poles
- Center grooved head for adjusting power stretcher head
- Easy-to-read, easy-to-adjust pin depth dial



Item No.	Description	Case Qty	Packaging
10-501	Golden Touch® Carpet Knee Kicker	3	Printed Carton
10-412-09	Replacement: Bumper Pad (2" thick)	1	Carton
10-422-09	Replacement: Bumper Pad (3" thick)	1	Carton

DELUXE HIGH-PROFILE KNEE KICKER



Featuring installer-designed enhancements, the Deluxe High-Profile Knee Kicker is engineered with a solid construction and durability.

- Trigger release adjusts from 18½" to 22½"
- High-contour neck for use over stretcher head and poles
- 50% thicker bumper pad for extra knee comfort
- 16% wider head for improved load distribution
- Non-slip, checkered hand grip
- Center grooved head for adjusting power stretcher head



Item No.	Description	Case Qty	Packaging
10-422BK	Deluxe High-Profile Knee Kicker	3	Printed Carton
10-412-09	Replacement: Bumper Pad (2" thick)	1	Carton
10-422-09	Replacement: Bumper Pad (3" thick)	1	Carton

DELUXE KNEE KICKER



Elevating the industry standard in knee kickers, the Deluxe Knee Kicker has been in use for over 40 years.

- Trigger release easily adjusts from 17" to 21"
- Non-slip, checkered hand grip
- Foam-filled seamless bumper pad for extra comfort
- Center grooved head for adjusting power stretcher head
- Easy-to-read, easy-to-adjust pin depth dial



Item No.	Description	Case Qty	Packaging
10-412-2	Deluxe Knee Kicker Silver (no case)	2	Printed Carton
10-412BKK	Deluxe Knee Kicker Black (with case)	3	Printed Wrap
10-412-09	Replacement: Bumper Pad (2" thick)	1	Carton
10-422-09	Replacement: Bumper Pad (3" thick)	1	Carton

⚠WARNING: Cancer and Reproductive Harm - www.P65Warnings.ca.gov. See P. 81, *Prop 65 - 2.

ADJUSTABLE KNEE KICKER



The Adjustable Knee Kicker is ideal for your basic carpet installation.

- Double locking pins easily adjust length from 19" to 23"
- High-contour neck for use over stretcher head and poles
- Center grooved head for adjusting power stretcher head
- Easy-to-read, easy-to-adjust pin depth dial



Scan Here
FOR PRODUCT INFO



Item No.	Description	Case Qty	Packaging
10-410	Adjustable Knee Kicker	3	Printed Carton
10-412-09	Replacement: Bumper Pad (2" thick)	1	Carton
10-422-09	Replacement: Bumper Pad (3" thick)	1	Carton

BUMPER PADS

Designed for use with adjustable knee kickers, the foam replacement bumper pads are compatible with The General® Knee Kicker, Golden Touch® Knee Kicker, Deluxe Knee Kicker, Deluxe High-Profile Knee Kicker and Adjustable Knee Kicker. Available in 2" or 3" thick sizes.



Item No.	Description	Case Qty	Packaging
10-412-09	Replacement: Bumper Pad (2" thick)	1	Carton
10-422-09	Replacement: Bumper Pad (3" thick)	1	Carton



NEW
AVAILABLE
FALL '25

POWERTAK™

Heavy driving force meets comfort and safety with our newest Electric Tacker - PowerTak™



Includes custom
blow-molded case

- Improved solenoid control panel, hardened striking pin, and staple driving force
- Trigger-activated, side-mounted LED lights help when stapling in dark corners or under stairnose
- Heavy-duty metal cap protects internal components from damage
- Two-step, integrated trigger for safety and convenience
- 7-1/4" low-profile design to fit in tight spaces
- Slender nose tip to part yarn for deep tacking
- Non-slip ergonomic grip for comfort and safety
- Spring-loaded, quick-release staple housing for refill speed and efficiency
- Staple-viewing window with full-strip capacity

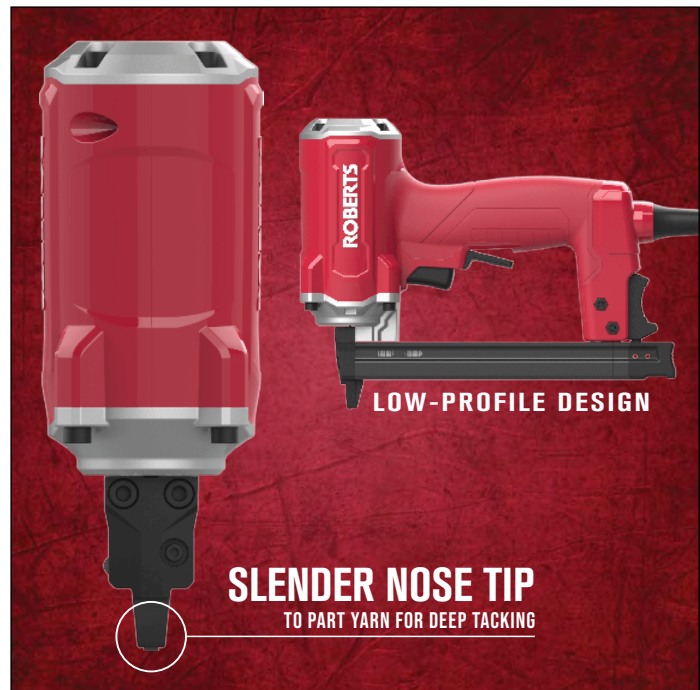

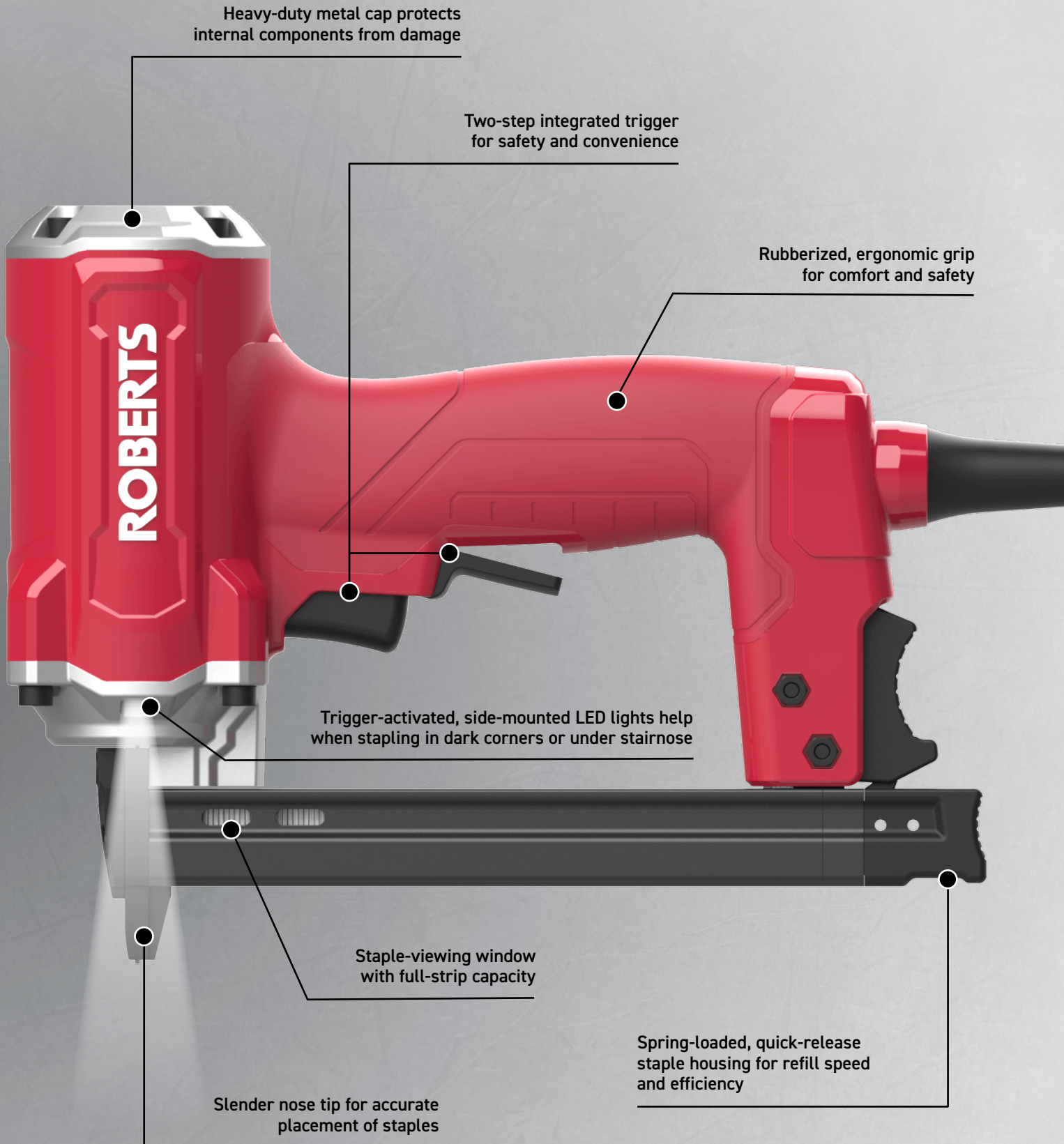

Heavy-duty metal cap protects internal components from damage

Two-step integrated trigger for safety and convenience

Rubberized, ergonomic grip for comfort and safety

Trigger-activated, side-mounted LED lights help when stapling in dark corners or under stairnose

Staple-viewing window with full-strip capacity

Spring-loaded, quick-release staple housing for refill speed and efficiency

Slender nose tip for accurate placement of staples

Item No.	Description	Case Qty	Packaging
10-610	PowerTak™ Electric Tacker (with carrying case)	1	Carrying Case

PROFESSIONAL ELECTRIC STAPLER



Powerful and reliable, the Professional Electric Stapler will meet the needs of the most demanding carpet installation.

- 6 3/8" low-profile head allows easy access in tight places, particularly stairs
- 120-v, 15 amp solenoid delivers more power to drive staples deeper
- Quick-release, bottom-loading magazine for fast reloading (85 staple capacity)
- Hardened driver mechanism shoots 20 gauge, 9/16" crown staples
- Heavy 14 gauge, 12' power cord offers maximum power and mobility
- Compatible with most standard 9/16" divergent point staples



Scan Here FOR PRODUCT INFO



Item No.	Description	Case Qty	Packaging
10-600	Professional Electric Stapler (with carrying case)	1	Carrying Case
110013-8	9/16" Divergent Point Staples (5000/box)	8	Printed Box

STAPLE HAMMER



The Staple Hammer is ideal for installing carpet padding, roofing felt, insulations, canvas framing and upholstery.

- Designed for quick, repetitive stapling
- Steel construction for superior durability
- Quick and easy back-end loading, holds 160 staples for more shots per load
- Comfortable, non-slip grip for extended use
- Compatible with 3/8" divergent point or chisel point staples



Item No.	Description	Case Qty	Packaging
10-109	Staple Hammer	6	Printed Carton
30-110	3/8" Chisel Point Staples (5000/box)	20	Printed Carton

CHISEL POINT STAPLES

V-shaped points of the Chisel Point Staples drive easily into most wood floors to prevent jamming.



- Ideal for wood flooring installation
- Can be used for heavy-duty jobs including wood material fastening, carpet padding, insulation, window screening, and upholstery
- Heavy-duty, high-carbon steel manufactured to reduce buckling and jamming
- 1/2 in. leg length for heavy-duty use

Item No.	Description	Case Qty	Packaging
30-110	3/8" Chisel Point Staples (5000/box)	20	Printed Carton

DIVERGENT POINT STAPLES

Engineered with 60° points and legs veering in opposite directions, Divergent Point 9/16" Staples provide added security / holding power.



- 3/8" crown staples with a 9/16" leg
- Easily penetrate vinyl tile, linoleum, felt and wood
- Staple legs veer in opposite direction to provide greater/extra holding power

Item No.	Description	Case Qty	Packaging
110013-8	9/16" Divergent Point Staples (5000/box)	8	Printed Carton

COOL SHIELD® HEAT BOND IRON



Designed to seam carpets like a professional, the Cool Shield® Heat Bond Iron melts 3" heat bond tapes while shielding carpets against heat damage.

- Double heat shield minimizes deforming of carpet backing and face yarn
- S-shaped heating element provides even heating and longer heat retention
- Comb profile forms ridges in adhesive for stronger carpet seams
- Top mounted thermostat control for easy heat-setting adjustments
- 3-way cord guide keeps the 9½' cord out of the way
- Grooved non-stick plate for fast, easy clean-up
- Thermostat indicator light shows when iron is heating
- Approximate heat range 135°F to 428°F



Scan Here FOR PRODUCT INFO



Item No.	Description	Case Qty	Packaging
10-482G	Cool Shield® Heat Bond Iron (110V)	3	Printed Carton

DELUXE HEAT BOND IRON



The Deluxe Heat Bond Iron is the first choice of carpet installation professionals worldwide.

- Low-profile design makes seaming carpet easy with 3" heat-bond seaming tapes
- Even heat distribution for faster more efficient melting
- Up-front thermostat control for easy heat-setting adjustments
- Thermostat indicator light changes from red to green when desired temperatures is achieved
- Heat shield prevents backings from overheating
- Comb profile forms ridges in adhesive for stronger carpet seams
- 2-way pivoting cord for easier control
- Non-stick coated plate for easy clean-up
- Approximate heat range 135°F to 425°F



Scan Here FOR PRODUCT INFO



Item No.	Description	Case Qty	Packaging
10-282G-2	Deluxe Heat Bond Iron (110V)	2	Printed Carton

6" HEAT BOND SEAMING IRON



The extra-wide 6" Heat Bond Seaming Iron is ideal for use with wider carpet seam tapes.

- Custom designed to distribute heat evenly from front to tail
- Grooved non-stick plate for fast, easy clean-up
- Up-front thermostat control for easy heat-setting adjustments
- Tapered base plate design joins carpet at back of iron
- 3-way cord guide keeps cord out of the way
- Approximate heat range 135°F to 425°F



Scan Here FOR PRODUCT INFO



Item No.	Description	Case Qty	Packaging
10-286G	6" Heat Bond Seaming Iron (110V)	3	Printed Carton

HEAVY-DUTY CARPET FLOORING ROLLERS

Ideal for pressing carpet into adhesive, the heavy-duty 100 and 75 lbs. rollers are designed to evenly distribute and flatten adhesive build-up, ensuring a level installation.



- Segmented, chrome-plated rollers ensure even pressure into flooring
- Detachable transport wheels protect the precision balanced rollers
- Designed with inset axles to prevent wall scuffing
- Removable 30" handle for convenient storage
- Includes custom blow-molded carrying case

Scan Here FOR PRODUCT INFO



10-950

Item No.	Description	Case Qty	Packaging
10-950	75 lbs. Heavy-Duty Flooring Roller	1	Box
10-952	100 lbs. Heavy-Duty Flooring Roller	1	Box
10-952-04	Replacement: Transport Wheel Assembly Kit	1	Carton

⚠️WARNING: Cancer and Reproductive Harm - www.P65Warnings.ca.gov. See P. 81, *Prop 65 - 1.

6" PRO CUT PILE CARPET SEAM ROLLER



Featuring smooth wheels and is designed to firmly press carpet backing into the seam tape without damaging carpet fibers.

- 6" head is optimally sized to work with most seam tapes
- Extended, angled handle provides optimal leverage
- Recessed hardware prevents damage or marking to walls
- Smooth wheels force carpet backing into seam tape



Item No.	Description	Case Qty	Packaging
10-124	6" Pro Cut Pile Carpet Seam Roller	3	Peg Card

6" PRO LOOP PILE CARPET SEAM ROLLER



Featuring star wheels for stronger seams, the 6" PRO Loop Pile Carpet Seam Roller is designed for use with loop pile and Berber carpets as well as securing carpet on tack strip.

- 6" head is optimally sized to work with most seam tapes
- Extended, angled handle provides optimal leverage
- Recessed hardware prevents damage or marking to walls
- Star wheels maximize hot-melt transfer into carpet back for stronger seams



Item No.	Description	Case Qty	Packaging
10-122	6" Pro Loop Pile Carpet Seam Roller	3	Peg Card

4.5" DELUXE CARPET SEAM ROLLER



Lightweight design and comfortable, non-slip handle make the 4.5" Deluxe Carpet Seam Roller ideal for use when seaming loop pile carpets.

- 3 rows of rollers to maximize adhesive absorption
- Extra-wide 4.5" head reduces dishing
- Lightweight design minimizes user fatigue
- Wide, nonslip handle makes the roller easy to use



Item No.	Description	Case Qty	Packaging
10-101	4.5" Deluxe Carpet Seam Roller	4	Peg Card

24" STEEL TOOL BOX



The 24" Steel Tool Box is designed with the pro installer in mind—rugged, spacious and multi-functional.

- Inset side handles safeguard durability during transport
- Dual-purpose storage tray serves as a seaming weight
- Heavy-duty steel construction for dependable, multifunctional use and toughness
- Full-length piano-style hinge for easy access
- Two heavy-duty fastening hasps, and locking loops for security
- 24" W x 9.75" H x 8.75" D, with plenty of space for a variety of installation tools



Piano-style hinge for easy access



Top



Bottom



Dual-purpose storage tray serves as a seaming weight

Inset side handles prevent damage during transport



Storage tray with nylon plates acts as a seaming weight

Item No.	Description	Case Qty	Packaging
10-163	24" Steel Tool Box	1	Printed Carton

Scan Here FOR PRODUCT INFO



⚠️WARNING: Cancer and Reproductive Harm - www.P65Warnings.ca.gov See P. 81, *Prop 65 - 1.

**NEW &
IMPROVED**

DELUXE CARPET INSTALLATION KIT

Key to an installer's success, the Deluxe Carpet Installation Kit features one each of the following:



Item No.	Description
10-163	24" Steel Tool Box
10-122	6" Pro Loop Pile Carpet Seam Roller
10-108	Professional 2" Strip Cutter
10-109	Staple Hammer
10-114	20-oz Ripping Hammer
10-146-3	Cushion Back Cutter
10-151	Nail Driving Bar
10-152-3	Loop Pile Cutter
10-616-2A	Conventional Carpet Trimmer
10-216	3-In-1 Carpet, Vinyl And Utility Knife
10-259	Pro Dual-Depth Carpet Knife
10-260	Deluxe Grip Tool Pouch
10-303S	Chalk Reel
10-412-2	Deluxe Knee Kicker
10-503	Pro Mini Pry Bar
10-521	4" Extra-Wide Stair Tool
10-522-4	EZ Tuk® Carpet Tucker
10-586-3	7" Duckbill Napping Shears
10-925	Vinyl Flooring Knife
10-140	30' Tape Measure
10-517	Row Finder & Separator
61613	White Rubber Mallet
10-321	White Chalk Refill 8-oz

**KIT
VALUE
SAVINGS
\$150**

Item No.	Description	Case Qty	Packaging
10-752	Deluxe Carpet Installation Kit	1	Printed Carton

Scan Here
FOR PRODUCT INFO



⚠WARNING: Cancer and Reproductive Harm - www.P65Warnings.ca.gov. See P. 81, *Prop 65 - 1.

NOTE: Contents may vary depending on inventory available.

PRO STAIR TOOL



Made from forged, chrome-plated steel for long-lasting strength and durability, the Pro Stair Tool is ideal for setting carpet into tack strip, driving carpet into gullies and creasing carpet along wall line.

- Heavy-duty 4" blade easily sets carpet into stairway crevices
- Chrome-plate steel design for added durability



Item No.	Description	Case Qty	Packaging
10-521	Pro Stair Tool	3	Peg Card

ROW FINDER & SEPARATOR



The Row Finder & Separator is ideal for separating carpet rows to minimize damage to nap and loops.

- Features tapered round end for cut pile carpets and flattened end for loop pile carpets
- Slip-resistant, checkered grip
- Steel construction for durability



Item No.	Description	Case Qty	Packaging
10-517	Row Finder & Separator	6	Peg Card

EZ TUK® CARPET TUCKER



A lightweight tucking tool, the EZ TUK Carpet Tucker will not mark or damage baseboards, walls, ceramic tiles or metal.

- Ball handle for a secure hold
- Curved edge is ideal for stairs
- Square edge works well for tucking carpet into corners
- 3½" wide blade for faster tucking



made in USA

Item No.	Description	Case Qty	Packaging
10-522-4	EZ TUK® Carpet Tucker	4	Peg Card

CARPET RAKE & GROOMER



The Carpet Rake & Groomer loosens and lifts embedded soil and hair from carpet. Ideal for quick and easy maintenance of cut pile carpet.

- Specially designed bristles reach deep into the base of carpet to loosen debris
- Extra-long 51" handle and 12" wide head grooms large areas quickly
- Three-part handle can be disassembled for quick, easy storage



Item No.	Description	Case Qty	Packaging
70-127-3	Carpet Rake & Groomer	3	Printed carton



CUTTING TOOLS

Whether the goal is cutting, trimming, slicing or scoring, you can expect precision, innovation and versatility with each of our products. Designed by pros for pros, we've taken every facet of cutting into account - from knife construction and blade angle to handle grip and blade storage, and everything in between.

CARPET TRIMMERS



Designed to quickly trim carpet along the wall or under toe kicks, Carpet Trimmers are an installer's must have carpet tool.

- 5-position folding handle moves easily in hard-to-reach areas
- Accommodates vertical and horizontal adjustments
- Anti-slip rubber handle and hardened stainless steel guide for accurate cuts

Item No.	Description	Case Qty	Packaging
10-616-2A	Carpet Trimmer Includes: 20 Heavy-duty Trimmer Blades	2	Printed Box
10-617GT	Golden Touch® Carpet Trimmer Includes: Dual layer spring steel blade clips	2	Peg Clamshell



10-616-2A

10-617GT

MULTIPURPOSE WALL TRIMMER



Ideal for cutting carpet, soft vinyl sheet goods, carpet tiles and cushion back for glue-down carpet, the stainless steel constructed Multipurpose Wall Trimmer makes clean cuts without marking walls.

- Fully adjustable for most material thicknesses
- Snap-on, anti-friction boot glides smoothly over sheet goods
- Hooked blades can be used to cut carpet tiles quickly and easily
- Slotted blades can be used for regular carpet or vinyl sheet goods

Item No.	Description	Case Qty	Packaging
10-905	Multipurpose Wall Trimmer	3	Peg Card



LOOP PILE CUTTERS



Developed for cutting loop pile carpets, the Loop Pile Cutter is stainless steel constructed for maximum durability.

- Throat opening adjusts automatically for different carpet backs
- Unique two-blade design accommodates both left and right hand cutting
- Direct-contact locking design keeps blades securely in place
- Ergonomic grip for comfort and control

Item No.	Description	Case Qty	Packaging
10-152-3	Loop Pile Cutter Includes: 15 Heavy-duty slotted blades	3	Peg Card
10-152GT	Golden Touch® Loop Pile Cutter	6	Peg Card

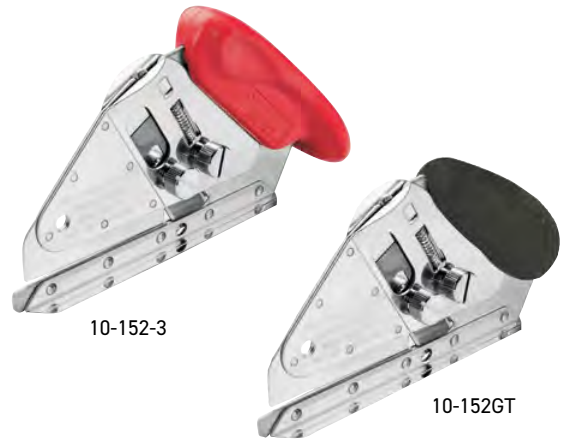

10-152-3

10-152GT

CUSHION BACK CARPET CUTTER



Made of stainless steel for maximum durability, the Cushion Back Carpet Cutter allows for left and right-handed cutting and is ideal to cut cushion back and conventional carpet.

- Industry-leading 4 mm thick stainless steel construction for maximum durability
- Press-fit design for faster blade change
- Soft, ergonomic grip for improved comfort
- Dual blades positioned at a 30° angle for improved cutting efficiency
- Tapered bottom glides between carpet rows for better separation
- Versatile, works with square- and round-ended carpet blades

Item No.	Description	Case Qty	Packaging
10-148	Cushion Back Carpet Cutter	3	Peg Card



10-148

UNIVERSAL SEAM CUTTER



The Universal Seam Cutter is designed for top and bottom carpet cutting.

- Superior dual design. Use slotted blade for top cutting or utility blade for bottom cutting
- Extra-long nose provides better row separation
- 50° blade angle permits cleaner precise cuts
- Quick-release blade replacement for fast blade changes

Item No.	Description	Case Qty	Packaging
10-154-3	Universal Seam Cutter	3	Peg Card



10" CARPET SHEARS



Featuring precision ground, high-quality carbon steel blades for maximum durability, the 10" Carpet Shears are ideal for use in-between areas like staircases and upholstery.

- Superior cutting ability and durability
- Accommodate large hands comfortably with vinyl-coated cushioned handle openings
- Blade edge sharpens easily on stone
- Chrome plated blades

Item No.	Description	Case Qty	Packaging
10-123	10" Carpet Shears	6	Polybag

made in
USA



⚠WARNING: Cancer - www.P65Warnings.ca.gov. See P. 81, *Prop 65 - 3.

8" NAPPING SHEARS



Manufactured with ground blades to ensure precision cuts, the 8" Napping Shears are the go-to tool for easy and level napping of carpet fibers.

- Offset-handles ensure level napping
- Accommodate large hands comfortably with extra-wide, vinyl-coated cushioned handle openings
- The blades are precision ground to ensure sharp cutting edges
- Chrome plated with knife edges

Item No.	Description	Case Qty	Packaging
10-121	8" Napping Shears	6	Polybag

made in
USA



⚠WARNING: Cancer and Reproductive Harm - www.P65Warnings.ca.gov. See P. 81, *Prop 65 - 1.

DUCKBILL NAPPING SHEARS



Designed for maximum durability, the Duckbill Napping Shears are the perfect tool for quick, easy and exact carpet trimming.

- Offset-handle design for easy blade positioning and level napping
- Accommodates large hands comfortably with extra-wide, vinyl-coated cushioned handle openings
- The blades are precision ground to ensure sharp cutting edges
- Chrome plated with knife edges

Item No.	Description	Case Qty	Packaging
10-585	6" Duckbill Napping Shears	6	Peg Card
10-586-3	7" Duckbill Napping Shears	3	Peg Card

made in
USA



⚠WARNING: Cancer - www.P65Warnings.ca.gov. See P. 81, *Prop65 - 3.

3-IN-1 CARPET, VINYL & UTILITY KNIFE

The 3-In-1 Carpet, Vinyl & Utility Knife is considered the premier knife among installers, largely due to its versatility. With a quick blade change, it can be used to install carpet, LVT/LVP - or as a utility knife.



- Patented insert with 3 positions according to blade type and cutting use
- NEW SWIVEL GRIP™ blade storage accommodates 20 individual blades or most 10-pack cartridges, and prevents blades from slipping through the seam
- 45° angle is optimal for scoring and breaking rigid materials
- Can be used with carpet, utility, hook, or concave blades according to need
- Ergonomic design and molded comfort grip for all-day use
- Easy flip-up thumb screw for quick blade access
- Pistol grip design and pinky hold for improved pulling power

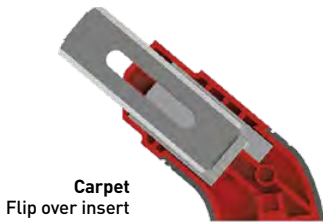

Accommodates 20 individual blades or most 10-pack cartridges

Item No.	Description	Case Qty	Packaging
10-216	3-in-1 Carpet, Vinyl & Utility Knife	6	Peg Card

PRO DUAL-DEPTH CARPET KNIFE



The Pro Dual-Depth Carpet Knife provides toolfree, easily adjustable blade depth options: 9/16" or 13/16" to accommodate different carpet back thickness.

- Patented insert provides toolfree, easily adjustable blade-depth options: 9/16" or 13/16" to accommodate different carpet thicknesses
- NEW SWIVEL GRIP™ blade storage accommodates 20 individual blades or most 10-pack cartridges
- Wider thumb stop for improved leverage, comfort and control
- Ergonomic design for a more comfortable fit in your hand
- Easy flip-up thumb screw for quick blade access
- Pistol grip design and pinky hold for improved pulling power



9/16"
Depth Setting

For low-pile carpets like Berbers



13/16"
Depth Setting

For high-pile carpets like Saxonomies



Accommodates 20 individual blades or most 10-pack cartridges

Item No.	Description	Case Qty	Packaging
10-259	PRO Dual-Depth Carpet Knife	6	Peg Card

PROFESSIONAL CARPET KNIFE



The Professional Carpet Knife is the go-to knife for professional installers.

- Special thumb-stop design provides safety and increased cutting pressure
- Easy push button for quick blade changing
- Knurled, slip-resistant grip assures firm grip
- Convenient, built-in blade storage inside the handle

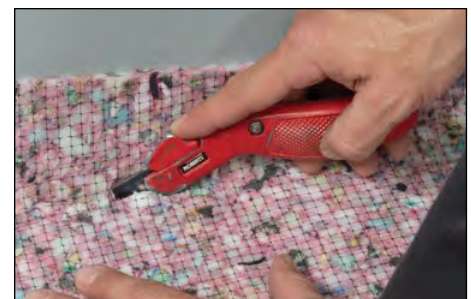

Item No.	Description	Case Qty	Packaging
10-252	Professional Carpet Knife (includes 3 blades)	6	Peg Card

CUT & JAM CARPET KNIFE



Uniquely designed to serve a dual function, the Cut & Jam Carpet Knife cuts carpet with one end and tucks carpet into gullies with the other.

- Features an easy-open knob with bail, safety thumb and blade guards
- Checkered handle for a slip resistant grip
- Rugged, lightweight precision die cast aluminum
- Handle stores up to 10 additional heavy-duty slotted blades



Item No.	Description	Case Qty	Packaging
10-220	Cut & Jam Carpet Knife (includes 3 blades)	6	Peg Card

RAZOR BLADE KNIFE



Featuring die-cast aluminum construction for lightweight durability, the Razor Blade Knife quickly and efficiently cuts carpet during installation.

- Features safety guards to keep blade firmly in place
- Checkered handle for a slip resistant grip
- Rugged, lightweight precision die cast aluminum
- Handle stores additional slotted blades



Item No.	Description	Case Qty	Packaging
10-215	Razor Blade Knife (includes 3 blades)	6	Peg Card

CARPET KNIFE



Easy to control and maneuver, and featuring a blade guard for added safety, the Slotted Blade Carpet Knife is the preferred choice of DIY installers.

- Contoured handle for precise cutting and firm grip
- Extra blade storage in the handle
- Large screw assembly offers easy blade changes



Item No.	Description	Case Qty	Packaging
10-253	Slotted Blade Carpet Knife (includes 2 blades)	12	Peg Card

⚠ WARNING: Cancer and Reproductive Harm - www.P65Warnings.ca.gov. See P. 81, *Prop 65 - 2.

BIG FATSO MULTIPURPOSE KNIFE



Ideal to mark, score or trim, the Big Fatso Multipurpose Knife is a great knife to have in your toolbox.

- Large contoured handle for comfort
- Offset head gives knuckle room and precise cutting angle
- Convenient on-board blade storage
- Accommodates both utility and hooked blades



Item No.	Description	Case Qty	Packaging
10-218F	Big Fatso Multipurpose Knife (includes 3 blades)	12	Peg Card
10-440	Replacement: Hooked Blades (1.84" long x .25" thick) 10 blades per card, 10 cards per case	10	Trapped Blister
10-404	Replacement Hawk Utility Blades (2.3" long x .75" wide x .67 mm thick) 5 blades per card, 10 cards per case	10	Trapped Blister

PRO UTILITY KNIFE



Developed to achieve professional results, the Pro Utility Knife cuts carpet, vinyl, drywall and roofing materials.

- Magnetic tip helps secure the blade in place
- Contoured handle provides improved grip and knife control
- Thumb wheel for quick-blade change
- Convenient on-board blade storage
- Accommodates both utility and hooked blades



Item No.	Description	Case Qty	Packaging
10-221	Pro Utility Knife (includes 3 blades)	6	Peg Card
10-440	Replacement: Hooked Blades (1.84" long x .25" thick) 10 blades per card, 10 cards per case	10	Trapped Blister
10-404	Replacement Hawk Utility Blades (2.3" long x .75" wide x .67 mm thick) 5 blades per card, 10 cards per case	10	Trapped Blister

PRO FIXED-BLADE UTILITY KNIFE

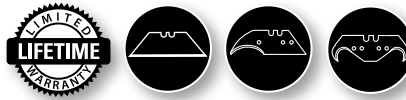

The Pro Fixed-Blade Utility Knife is perfect for marking, scoring, trimming and cutting a variety of materials.

- Checkered handle for a slip-resistant grip
- Easy-open knob with bail for quick-blade change
- Convenient on-board blade storage
- Accommodates both heavy-duty utility and hooked blades



Item No.	Description	Case Qty	Packaging
10-920-6	Pro Fixed-Blade Utility Knife (includes 3 blades)	6	Peg Card
10-440	Replacement: Hooked Blades (1.84" long x .25" thick) 10 blades per card, 10 cards per case	10	Trapped Blister
10-404	Replacement Hawk Utility Blades (2.3" long x .75" wide x .67 mm thick) 5 blades per card, 10 cards per case	10	Trapped Blister

VINYL FLOORING KNIFE



High-quality, versatile knife cuts and tucks with ease and precision.

- Curved blade slices linoleum, vinyl sheet goods and carpet
- Tapered, flat-top surface for use as a carpet tucker
- Blade made from hardened stainless steel for extra durability
- Soft, installer-preferred grip for enhanced performance and comfort



Item No.	Description	Case Qty	Packaging
10-925	Vinyl Flooring Knife	12	Peg Card

LONGNECK PLUS 6" JAMB SAW



Fitted with a powerful 1100-watt industrial-grade motor, the Longneck Plus 6" Jamb Saw cuts doors, jambs, trim and molding for installation of new floors, as well as brick and cement block.

- Patented design enables saw to cut full inside corners in molding up to 1/2" thick
- Extended "tail" for maximum leverage against torque
- Adjustable cutting-depth guide prevents cutting into plaster or wall board when trimming base boards
- Precision height adjustment from "flush" to 1-1/16"
- 1 1/2" vacuum port for optimal dust containment
- 1100-watt, 120V ~ 60Hz, 9.6 AMPs motor cuts with ease
- Includes one 6-3/16" 36-Tooth Carbide-Tipped Saw Blade (10-47-2) and one 6" Masonry Blade (10-55-24)
- Includes custom-molded carrying case



Scan Here
FOR PRODUCT INFO



Item No.	Description	Case Qty	Packaging
10-56	Longneck Plus 6" Jamb Saw (with carrying case)	1	Carrying Case
10-47-2	Replacement: 6-3/16" 36-Tooth Carbide-Tipped Saw Blade	2	Trapped Blister
10-47-6	Replacement: 6-3/16" 20-Tooth Carbide-Tipped Saw Blade	6	Trapped Blister
10-55-24	Replacement: 6" Masonry Blade	1	Trapped Blister



Vacuum hose sold separately



SUPER SIX 6" JAMB SAW



The Super Six 6" Jamb Saw is a powerful, versatile undercutting tool that easily trims door jambs, baseboards, cabinet toe kicks, inside corners and most hanging doors.

- Patented design enables saw to cut full inside corners in molding up to 1/2" thick
- Spiral ground gears and ball-and-needle bearings for quiet operation and smooth blade rotation
- Adjustable cutting-depth guide prevents cutting into plaster or wall board when trimming base boards
- Precision height adjustment from "flush" to 1-1/16"
- 6' cord for easier movement while cutting
- 900 watts, 120V ~ 60Hz, 7.5 AMPs motor cuts with ease



Scan Here
FOR PRODUCT INFO



Item No.	Description	Case Qty	Packaging
10-46	Super Six 6" Jamb Saw (with carrying case)	1	Carrying Case
10-47-2	Replacement: 6-3/16" 36-Tooth Carbide-Tipped Saw Blade	2	Trapped Blister
10-47-6	Replacement: 6-3/16" 20-Tooth Carbide-Tipped Saw Blade	6	Trapped Blister

JAMB SAW REPLACEMENT BLADES

Compatible with our Longneck Plus and Super Six 6" Jamb Saws, our replacement blades are designed with resilience and precision in mind.

- Designed for cutting door jambs, baseboards and along walls
- Carbide tipped for added toughness and durability
- Anti-s snag blade resists catching on hidden nails
- Recessed arbor for flush cuts
- Masonry blade easily cuts through brick and cement block



Item No.	Description	Case Qty	Packaging
10-47-2	6-3/16" 36-Tooth Carbide-Tipped Saw Blade	2	Trapped Blister
10-47-6	6-3/16" 20-Tooth Carbide-Tipped Saw Blade	6	Trapped Blister
10-55-24	6" Masonry Blade	1	Peggable Clamshell
10-42	4 1/4" 20-Tooth Carbide-Tipped Saw Blade	6	Trapped Blister

HOOKED BLADES

Precision sharpened for accurate cutting, Hooked Blades are ideal for use with carpet knives, trimmers and cutters.

- Heavy-duty, high-quality steel for professional results
- Hooked blade design features two positioning stops for added versatility



Item No.	Description	Case Qty	Packaging
10-440	Hooked Blades (1.84" long x .25" thick) 10 blades per card, 10 cards per case	10	Trapped Blister

made in
USA

HAWK UTILITY BLADES

Designed for cutting and scoring various materials including LVP, acrylic light panels, vinyl tile, rubber and flooring underlayment.

- Tough carbon steel blade offers dependable, everyday cutting and trimming
- Fits most standard utility knives



Item No.	Description	Case Qty	Packaging
10-404	Hawk Utility Blades (2.3" long x .75" wide x .67 mm thick) 5 blades per card, 10 cards per case	10	Trapped Blister

STRIP CUTTER BLADES

Strip Cutter Blades are manufactured to be used with Professional Strip Cutter.

- Blades are made of high-carbon steel for hardness and durability
- 1.86" long x .45" wide x 0.38" thick

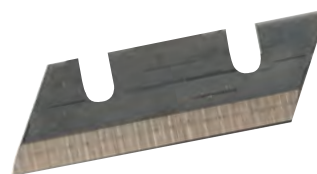

Item No.	Description	Case Qty	Packaging
10-439	Strip Cutter Blades Blister Cards (1.86" long x .45" wide x 0.38" thick) 6 blades per card, 10 cards per case	10	Trapped Blister



STICK WITH US FOR A SURE STEP.

For permanent installations of carpet / vinyl flooring, to safety tread for stairs, or a non-slip grip to hold your rugs and mats in place, ROBERTS® offers a tape that meets your flooring needs.



MAX GRIP®

VINYL TAPE

Scan here for PRODUCT INFORMATION



- For permanent installation of vinyl flooring, wall base, stair, tread and vinyl trim



TREAD TAPE

ANTI-SLIP SAFETY STRIP

Scan here for PRODUCT INFORMATION



- Provides extra traction on stairs, ramps, loading docks and ladders



RUG GRIPPER™

FOR HIGH-TRAFFIC INDOOR RUGS

Scan here for PRODUCT INFORMATION



- Offers non-slip strength to keep rugs and mats from bunching up or sliding across the floor



50-540
50-550
50-560
50-565



50-585



50-580
50-588



TACK STRIP

One of the most important tools in carpet installations, the tack strip ensures that your carpet stays locked in position. Once gripped, they help to keep the seams of your carpet tight and prevent it from stretching out of shape over time.

SMOOTHEDGE® PEEL & STICK CARPET TACK STRIP

Designed to make carpet installation quick and easy, the SmoothEdge® Peel & Stick Carpet Tack Strip instantly grips carpet and allows for immediate stretching.

- Perfect for installing carpeting over wood or concrete subfloors
- Suitable for commercial or residential applications
- Grips instantly, immediately ready for stretching
- Manufactured using Carb Phase II and TSCA title VI compliant materials
- Covers 360 lineal feet



Item No.	Description	Case Qty	Packaging
20-1450	SmoothEdge® Peel & Stick Carpet Tack Strip (3-pk) 7/8" wide x 4' long	30 Packs (90 each)	Display Carton

PROFESSIONAL 2" STRIP CUTTER



Forged from rugged steel construction, the Professional 2" Strip Cutter is designed to cut tack strip and architectural strip without extra effort.

- Powerful cutting force, 8-to-1 leverage
- Blade storage in handle



made in
USA



Item No.	Description	Case Qty	Packaging
10-108	Professional 2" Strip Cutter	3	Pegged Card
10-439	Replacement: Strip Cutter Blades (6 blades per pack; 10 cards per case)	10	Blister Card

10 GAUGE CONCRETE NAILS

Featuring a heavy 10-gauge shank, the 5/8" Concrete Nail is ideal for use on extremely hard or aged concrete where a 12-gauge nail could bend or break.

- Precision-ground blade for added sharpness and durability
- Hard nails feature a short and thick shank with excellent piercing and fixing strength
- Manufactured for use with a carpet tack strip over concrete subfloors during carpet installation



Item No.	Description	Case Qty	Packaging
33-100	5/8" Concrete Nails (1 lb. bag)	10	Poly-bag

NAIL DRIVING BAR



The Nail Driving Bar is the perfect solution for hammering nails in hard-to-reach places including under radiators, toe kicks, overhangs and next to glass doors.

- Magnetic head holds nails in place for easy starting
- 12-3/8" length helps access hard-to-reach areas
- Steel construction provides extra durability and extends product life
- Soft, non-slip handle helps improve handling



Item No.	Description	Case Qty	Packaging
10-151	Nail Driving Bar	6	Printed Carton



THE FIRST & ONLY FLOORING ADHESIVE

POWERED WITH MICROBAN®*



ROBERTS® AND MICROBAN® OFFER SUPERIOR PROTECTION AND PEACE OF MIND



*Excludes ROBERTS® 1550 MAXCOMPLETE®

ROBERTS® Moisture Control Adhesives

Our best-in-class resilient flooring adhesives are equipped with moisture control technology to withstand moisture vapor emission rates (MVER) up to 12 lbs., and relative humidity (RH) up to 99%. Our premium urethane wood adhesives provide unlimited moisture vapor protection and require no moisture testing.

SAVE TIME. SAVE STEPS. SAVE MONEY.



UP TO 12 LBS.



UP TO 10 LBS.

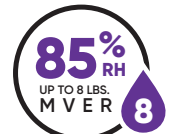

UP TO 8 LBS.



SHELF LIFE
2 YEARS

Extended Product Shelf Life

Powered with Microban® antimicrobial technology, ROBERTS adhesives now offer a **2-Year Shelf Life** when stored in the original, unopened container in a controlled environment.



LIFETIME
WARRANTY

Lifetime Warranty

Adhesives bearing this mark qualify for lifetime coverage, only when installation is performed by an Industry Certified Installer in compliance with all product usage guidelines specified by flooring manufacturer, industry standard floor preparation product specifications, and ROBERTS' adhesive specifications.



CERTIFIED BY
SCS Global Services

Products that are **FloorScore** certified meet the air quality emissions criteria for LEED, CHPS and the Green Guide for Health Care.

Scan Here
to Learn More





VINYL TOOLS

Improve the speed and efficiency of your next flooring install with rugged, easily transportable vinyl tools. From professional floor and tabletop cutters to flooring rollers and trimmers, our products are designed to support precision, improve efficiency, and help ensure success with your vinyl flooring installation project.

POWER-LOK EXTENDIBLE FLOOR ROLLER

Designed with the professional installer in mind, the Power-Lok Extendible Floor Roller is a "must have" for installing a wide assortment of flooring including sheet vinyl, VCT and linoleum. Spring-loaded metal collar locks, extends and retracts length quickly.



- 7 locking positions extends length from 18" to 28"
- Unique, quick-release mechanism for easy length adjustment
- Recessed roller hardware protects against damage to floors or walls
- Segmented rollers provide even pressure and maximum transfer of adhesive to the floor covering
- Smooth metal handgrip leverages body weight for improved control and increased pressure

Item No.	Description	Case Qty	Packaging
10-975	Power-Lok Extendible Flooring Roller	2	Vinyl Wrap

⚠️WARNING: Cancer and Reproductive Harm - www.P65Warnings.ca.gov. See P. 81, *Prop 65 - 1.

Scan Here
FOR PRODUCT INFO

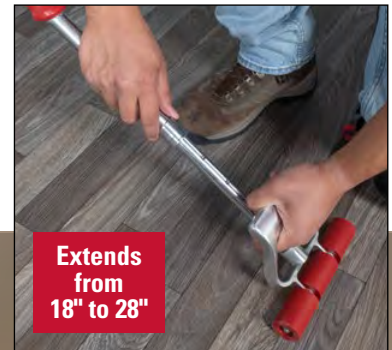

VINYL SEAM ROLLER



The Vinyl Seam Roller is used to secure wall base and roll seams on VCT and sheet vinyl.

- 2" x 2" polished steel roller mounted on two smooth rolling ball bearings for quick, easy use
- Rounded outside edge to prevent marring or scratching walls and flooring
- Designed for superior grip and better leverage

NEW & IMPROVED



Item No.	Description	Case Qty	Packaging
10-963	Vinyl Seam Roller	6	Tagged & Display Box

VINYL FLOORING ROLLER



Ideal for pressing VCT, linoleum, carpet, sheet vinyl, cork underlayment and other floor materials into adhesive. Designed with heavy-duty flooring rollers to evenly distribute and flatten adhesive build-up, ensuring a level installation.

- Segmented, chrome-plated rollers ensure even pressure into flooring
- Designed with inset axles to prevent wall scuffing
- Removable 30" handle for convenient storage

Item No.	Description	Case Qty	Packaging
10-935	35 lbs. Vinyl & Linoleum Flooring Roller	1	Box
10-952-04	Replacement: Transport Wheel Assembly Kit	1	Box

* For heavier rollers, see page 20.

⚠WARNING: Cancer and Reproductive Harm - www.P65Warnings.ca.gov. See P. 81, *Prop 65 - 1.



Scan Here FOR PRODUCT INFO



TOPSET GOUGE



This handy tool has a U-shaped, wide blade for grooving the back of vinyl or rubber cove base materials, permitting the material to be neatly bent around corners.

- 5/32" blade adjusts for depth and can be sharpened
- Hardwood handle for comfortable use

Item No.	Description	Case Qty	Packaging
10-279	Topset Gouge	12	Half Clamshell



Canada Only



QUIK-CUT VINYL TILE CUTTER



The Quik-Cut Vinyl Tile Cutter cuts vinyl tiles up to 12" x 12" and up to 4mm thick.

- Die-cast aluminum base for added durability
- Built-in measuring gauge for cutting accuracy
- Hardened steel blades
- Ball and needle bearings for precise operations

Item No.	Description	Case Qty	Packaging
30002	Quik-Cut Vinyl Tile Cutter	3	Printed Carton



Scan Here FOR PRODUCT INFO



12" VINYL TILE CUTTER



The 12" Vinyl Tile Cutter is ideal for quick and repetitive cutting of 12" x 12" vinyl tile up to 4mm thick.

- Hardened steel blade delivers accurate cuts and durability
- Built-in ruler provides cutting guide
- Molded handle provides firm, comfortable grip
- Locking blade for safety and convenient handle for easy transport



Scan Here
FOR PRODUCT INFO



Item No.	Description	Case Qty	Packaging
10-895	12" Vinyl Tile Cutter	3	Printed Carton

18" PRO VINYL TILE CUTTER

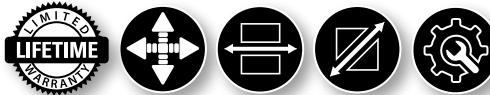

The 18" Pro Vinyl Tile Cutter can rip-cut vinyl flooring up to 18" (12" diagonally) and up to 1/8" thick. Specially designed to cut solid vinyl tile, vinyl composition tile (VCT), luxury vinyl tile and cork tile.

- Cutting guide and 45° miter guide ensures accurate cutting
- Hardened, adjustable 18" steel blade ensures clean, precise cuts
- Built-in casters for greater maneuverability
- Rubber feet improve stability to hold steady while cutting
- Durable, lightweight aluminum base with slotted handle to easily carry



Scan Here
FOR PRODUCT INFO



Item No.	Description	Case Qty	Packaging
10-918	18" Pro Vinyl Tile Cutter	1	Printed Carton

12" PRO VINYL TILE CUTTER



The 12" Pro Flooring Cutter is specially designed to cut solid vinyl tile, vinyl composition tile (VCT), luxury vinyl tile and cork tile. Delivers precise rip-cuts on flooring up to 12" (9" diagonally) and up to 1/8" thick.

- Adjustable cutting guide and 45° miter guide ensures accurate cutting
- Hardened, adjustable 12" steel blade ensures clean, precise cuts
- Built-in casters for greater maneuverability
- Rubber feet improve stability to hold steady while cutting
- Includes custom blow-molded carrying case

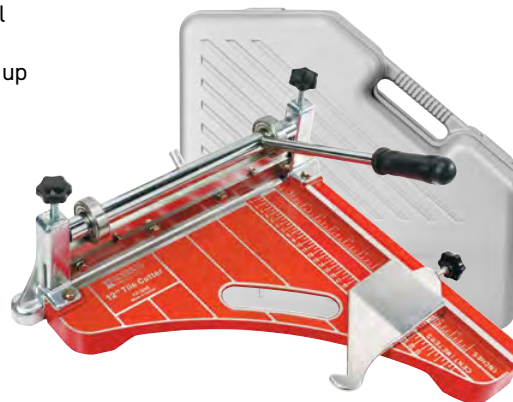

Scan Here
FOR PRODUCT INFO



Item No.	Description	Case Qty	Packaging
10-900	12" Pro Vinyl Tile Cutter	1	Printed Carton

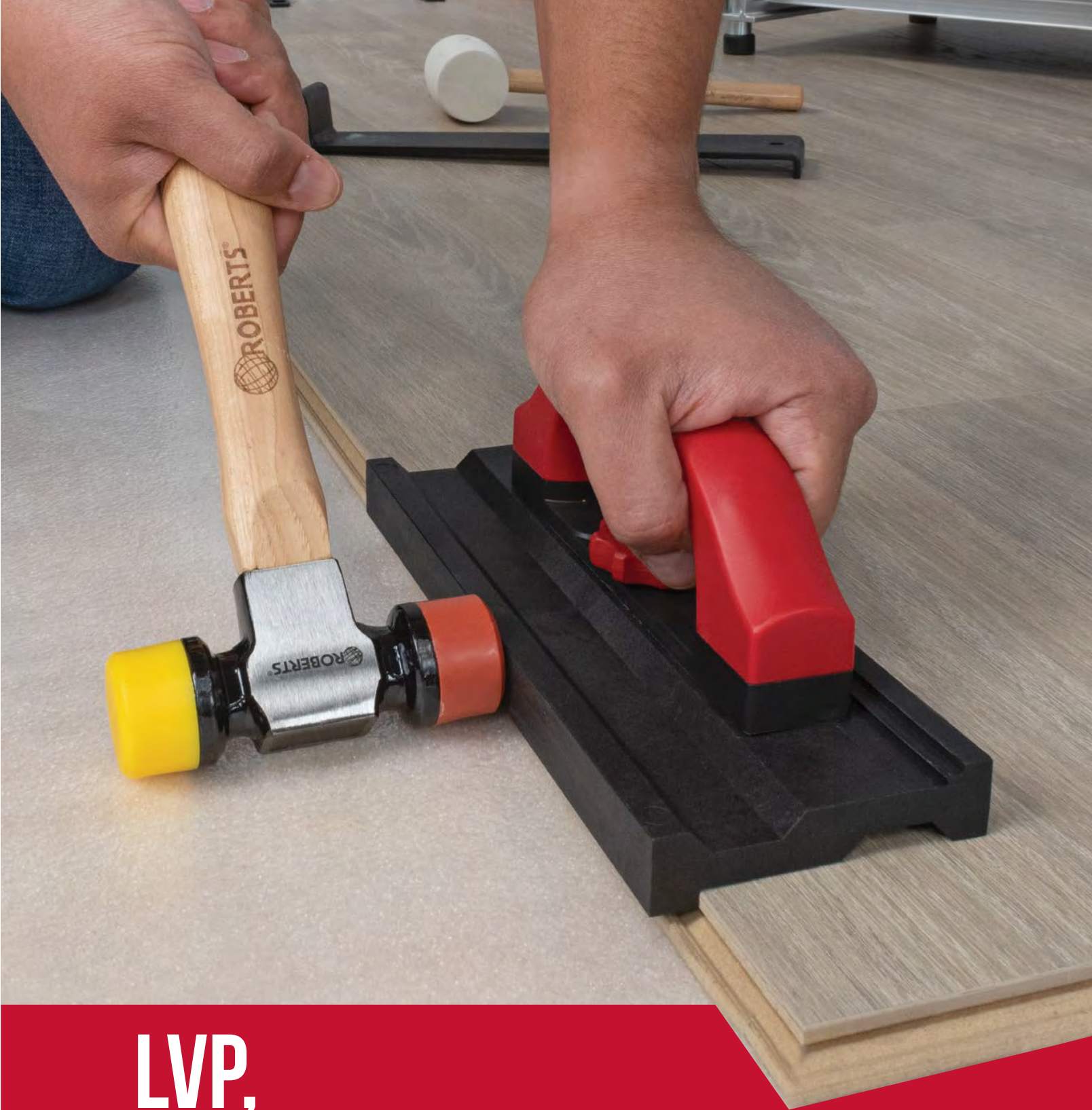

LVP, LAMINATE & WOOD TOOLS

Specifically engineered for the installation of LVP, laminate and wood floors, our multi-floor cutters, installation kits, putties and individual flooring tools are precision crafted, thoughtfully designed and take into account feedback of today's top installers. Rugged, durable, dependable and reusable, these wood and laminate flooring tools are ready to take on your next installation project.

PRECISION CUTS

PRO MULTI-FLOOR CUTTERS

AVAILABLE IN 25", 18", 13" AND 9"

Precision designed to quickly cut carpet tile, laminate, engineered wood flooring, vinyl plank flooring, siding, VCT tile, PVC and other flooring materials.



- Large steel rollers for smooth action and increased cutting power
- Incorporated toggle switch to lock blade in place
- Thicker blade carriage for more force in cutting • Cutting blade accommodate straight edges or angled cuts
- Ideal for carpet tile (10-959 only)



Built-in ruler features both inches and millimeters for convenience



Built-in light for improved cutting view

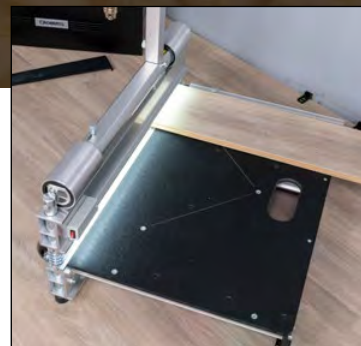

Cutting guide accommodate straight edges or angled cuts

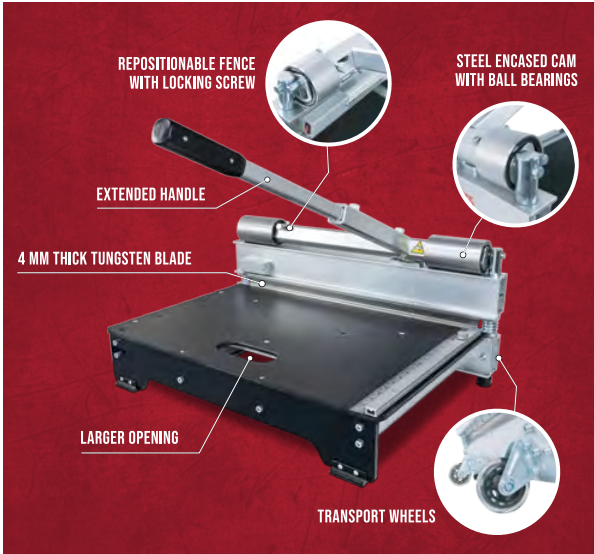

25 INCH



10-959



Trims flooring up to 25" wide, 17" diagonal & 5/8" (16 mm) thick

18 INCH



10-997



Trims flooring up to 18" wide, 12.5" diagonal & 5/8" (16 mm) thick

13 INCH



10-942



Trims flooring up to 13" wide, 8.5" diagonal & 5/8" (16 mm) thick

9 INCH



10-911



Trims flooring up to 9" wide & 5/8" (16 mm) thick

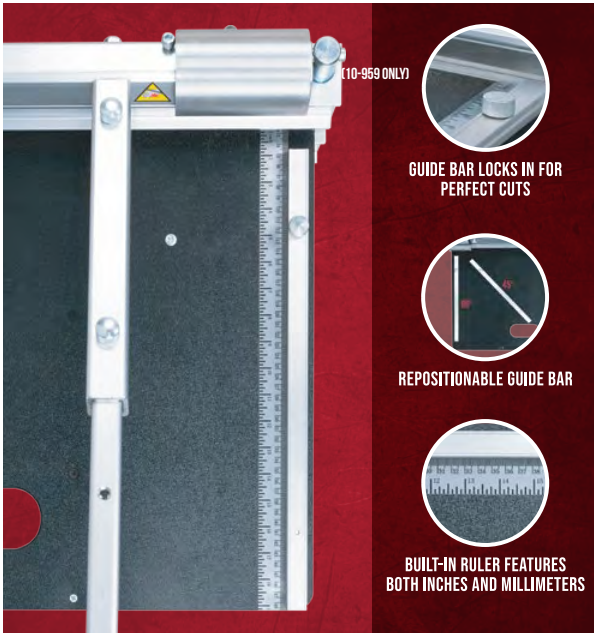

Item No.	Description	Case Qty	Packaging
10-959	25" PrecisionCuts™ Pro Multi-Floor Cutter	1	Printed Carton
10-495	Replacement: 25" Tungsten Carbide Blade	1	Tube
10-997	18" PrecisionCuts™ Pro Multi-Floor Cutter	1	Printed Carton
10-990	Replacement: 18" Tungsten Carbide Blade	1	Tube
10-942	13" PrecisionCuts™ Pro Multi-Floor Cutter	1	Printed Carton
10-940	Replacement: 13" Tungsten Carbide Blade	1	Tube
10-911	9" PrecisionCuts™ Pro Multi-Floor Cutter	1	Printed Carton
10-910	Replacement: 9" Tungsten Carbide Blade	1	Tube

13" MULTI-FLOOR CUTTER



Manufactured to quickly cut laminate, engineered wood flooring, vinyl plank flooring, vinyl wood and more. The 13" Multi-Floor Cutter trims flooring up to 13" wide and 12 mm thick.

- Table miter gauge for angled cuts 0° - 45°
- Extended handle provides extra leverage for more cutting power with less effort
- Replaceable, resharpenable tungsten blade



Item No.	Description	Case Qty	Packaging
10-63	13" Multi-Floor Cutter	1	Printed Carton
10-463	Replacement: 13" Tungsten Carbide Blade	1	Clamshell

9" MULTI-FLOOR CUTTER



Manufactured to quickly cut carpet tile, laminate, engineered wood flooring, vinyl plank flooring, LVT and VCT tile. The 9" Multi-Floor Cutter is made of heavy-duty steel.

- T-base design provides maximum stability
- Hardened steel blade delivers accurate cuts and durability
- Molded handle provides firm, comfortable grip
- Locking blade for safety and convenient handle for easy transport



Item No.	Description	Case Qty	Packaging
10-60	9" Multi-Floor Cutter	1	Printed Carton
10-460	Replacement: 9" Tungsten Carbide Blade	1	Clamshell

WARNING: Cancer and Reproductive Harm - www.P65Warnings.ca.gov. See P. 81, *Prop 65 - 4.

8" LAMINATE & VINYL PLANK CUTTER



Blunt-blade design cuts laminate and vinyl plank flooring up to 8" wide and 10 mm thick, the 8" Laminate & Vinyl Plank Cutter is made of heavy-duty steel.

- Features blunt, no-sharp cutting edge that prevents laminate from splitting
- Non-slip grip for max comfort and superior leverage
- Sturdy, positionable V support keeps planks level while cutting



Features blunt blade to prevent splitting

Item No.	Description	Case Qty	Packaging
10-35	8" Laminate & Vinyl Plank Cutter	1	Printed Carton



Scan Here
FOR PRODUCT INFO



REPLACEMENT FLOORING CUTTER BLADES

Featuring long-lasting 4 mm tungsten blades, ROBERTS® Replacement Flooring Cutter Blades ensure sharp, clean cutting edge.

Item No.	Description	Case Qty	Packaging
10-468	Replacement: 25" Blades for 10-95	1	Clamshell
10-910	Replacement: 9" Blades for 10-91	1	Clamshell
10-940	Replacement: 13" Blades for 10-94	1	Clamshell
10-990	Replacement: 18" Blades for 10-99	1	Clamshell

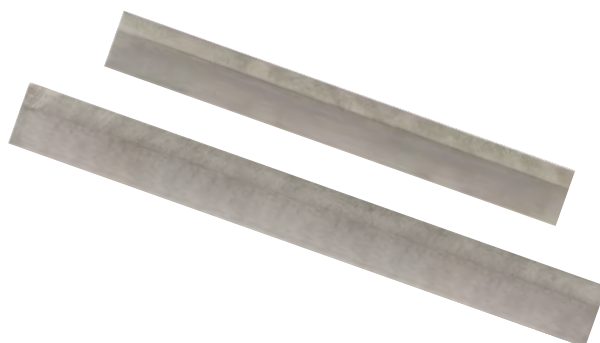

4-IN-1 EXPANSION JOINT SPACERS



For use with floating or glue-down vinyl, laminate or hardwood flooring installations. Patented 4-sided spacers allow for 1/4" (6 mm), 3/8" (9.5 mm), and 1/2" (13 mm) expansion gaps, along the wall and 1" (25 mm) for thresholds between rooms.

- Provides space along the room perimeter to allow for expansion and contraction of flooring
- Self-bracing to remain upright throughout installation
- Made of durable, hard plastic that resist compression



US Patent No. 12,024,897

Item No.	Description	Case Qty	Packaging
10-36	4-in-1 Expansion Joint Spacers (30 Count)	8	Polybag and Display Box

PRO FLOORING INSTALLATION KIT



Ideal for use with vinyl, laminate, and hardwood flooring installations, the Pro Flooring Installation kit is designed for floating or glue-down installations.

Kit includes: 4-in-1 Expansion Joint Spacers, Universal Tapping Block, Wide Angle Pull Bar, and a Double-Faced Mallet



Item No.	Description	Case Qty	Packaging
10-43	Pro Flooring Installation Kit	6	Printed Carton



FLOORING INSTALLATION KIT



The Flooring Installation Kit is used to install tongue and groove flooring as well as glue-down and floating floor applications.

Kit includes: Tapping Block, Pull Bar, and Wedge Spacers



Item No.	Description	Case Qty	Packaging
10-26	Flooring Installation Kit (30 Wedge Spacers)	10	Printed Carton
10-28	Flooring Installation Kit (50 Wedge Spacers)	6	Printed Carton

EXPANSION JOINT WEDGE SPACERS



Expansion Joint Wedge Spacers are designed to create space between the floor material and wall in floating flooring installations.

- Prevents flooring from moving during installation
- Made of durable, hard plastic that resist compression
- Serrated surface locks wedge spacer into position once plank is placed against it

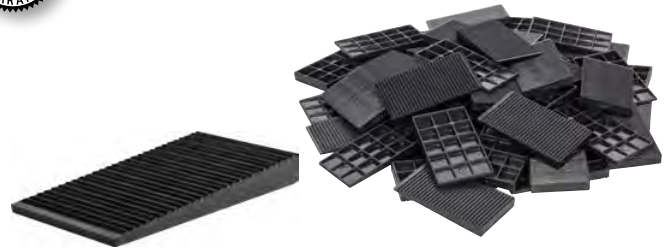

Item No.	Description	Case Qty	Packaging
10-27	Expansion Joint Wedge Spacers (30 wedges)	6	Polybag

UNIVERSAL TAPPING BLOCK



Uniquely engineered with dual-purpose edges, the Universal Tapping Block is specifically designed for resilient vinyl tile, plank flooring, tongue and groove floors, and click-lock floors.

- Two-sided design accommodates click-lock or tongue and groove flooring
- Protects flooring edge from damage

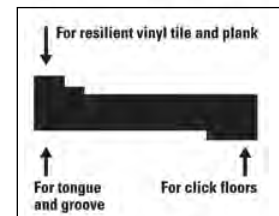
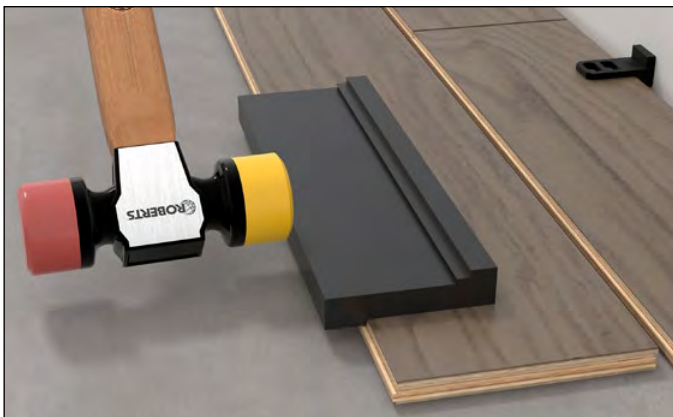

Combination Edge Design

Item No.	Description	Case Qty	Packaging
10-25	Universal Tapping Block	8	Label

DOUBLE TAP® REVERSIBLE TAPPING BLOCK



ROBERTS® patented 10" Double Tap® Reversible Tapping Block is designed to push flooring planks together without damaging the joining grooves of the flooring or your fingers.

- Double-sided with notches designed for tongue and groove, as well as click-lock laminate, engineered wood, or vinyl tile planks
- D-handle can be removed and reattached to either side of the block depending on flooring type installed
- Offset handle keeps hands and fingers away from strike zone



US Patent No. 12,188,242

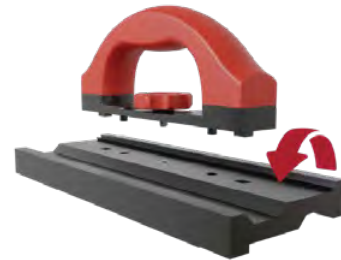

Scan Here
FOR PRODUCT INFO



Item No.	Description	Case Qty	Packaging
10-49	Double Tap® Reversible Tapping Block	8	Printed Wrap and Display Box

⚠WARNING: Cancer and Reproductive Harm - www.P65Warnings.ca.gov. See P. 81, *Prop 65 - 1.



THE MAVERICK® WIDE ANGLE PULL BAR

ROBERTS® THE MAVERICK® Wide Angle Pull Bar helps tighten seams during laminate, vinyl and wood flooring installation.



- Triangle-shaped head can better withstand the strike force of a mallet than standard N-shaped pull bars
- Extra-long 16" length for better maneuverability
- Reaches against a wall cabinet, toe kick or other hard to reach spaces where a tapping block will not fit
- Forged from premium steel construction for durability
- Soft felt pads protect against damage to floors



Item No.	Description	Case Qty	Packaging
10-018	THE MAVERICK® Wide Angle Pull Bar	6	Label and Display Box

PRO PULL BAR

Forged from premium steel construction, the Pro Pull Bar is used to gently pull together planks of floating floors and glue-down installations of all brands of tongue and groove flooring. Ideal for use in tight spaces, and against walls.

- 16½" long, angled profile allows planks to be tapped together in tight areas and at walls
- Premium steel construction
- Soft felt pads protect against damage to floors



Item No.	Description	Case Qty	Packaging
10-18-8	Pro Pull Bar	8	Label



DISCOVER SUPERIOR MOISTURE CONTROL & MAXIMUM BOND STRENGTH



MOISTURE
RESISTANCE



SHELF LIFE
2 YEARS



LIFETIME
WARRANTY*

ROBERTS® 7350 UNIVERSAL is a high-quality, high-solids formulation for installation of resilient flooring and vinyl-backed carpet tile. This acrylic latex, pressure-sensitive adhesive has tremendous bond and shear strength, making it ideal for use with large format vinyl tiles. It has excellent moisture and plasticizer migration resistance for demanding commercial installations and offers a releasable or permanent-bond application method.





UNIVERSAL TOOLS

One of the greatest attributes of a tool in an installer's toolbox is its ability to be used in numerous installation environments or for different types of projects. With this versatility in mind, we offer heavy cargo dollies and Dual Air Glider, knee pads, scrapers and other tear-out tools to help transport furniture / heavy equipment, remove unwanted flooring debris, and prepare subfloors for new installation projects.

NEW

DUAL AIR GLIDER

Functioning much like a hovercraft, the Dual Air Glider can lift up to 800 lbs. to transport furniture, appliances and machinery without damaging floors.



- 1.75 (120 V) HP blower provides a 800 lbs. lift capacity
- 8½" x 36" dual vacuum platforms
- Improved motor output connector
- Polypropylene slider boards for moving over carpet and other porous surfaces
- Includes carrying case
- Lifts up to 800 lbs.

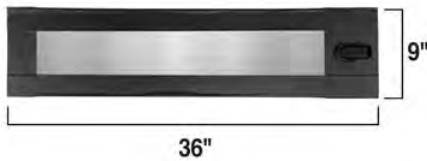

For use on hard surfaces (i.e., concrete, wood, etc.)



For use on soft, porous surfaces (i.e., carpet, vinyl, etc.)



Item No.	Description	Case Qty	Packaging
10-485	Dual Air Glider (120 V)	1	Plain Box



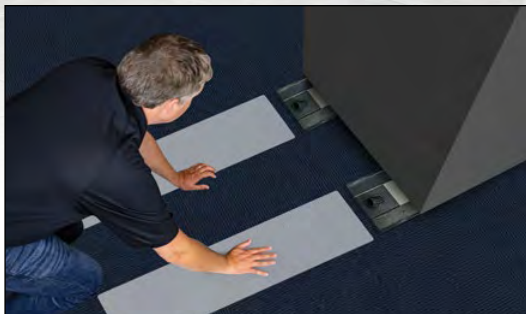

Includes two 9" x 38" polypropylene slider boards for lifting on carpet

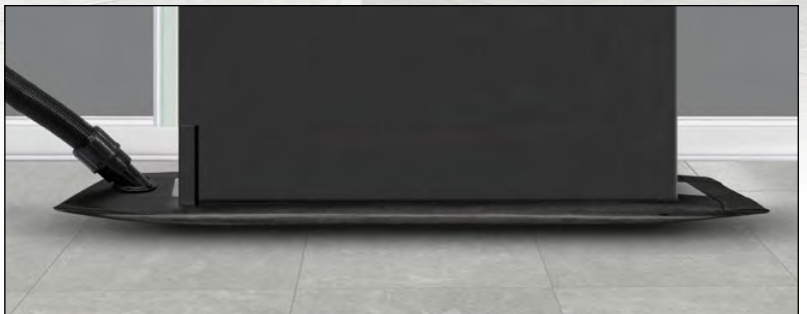

Lifts up to 800 lbs.

HEAVY CARGO DOLLIES



Expertly manufactured for transporting heavy loads. The Heavy Cargo Dollies are ideal for moving rolls of carpet, sheet goods, furniture, appliances and equipment.

- Each dolly holds up to 1,000 lbs.
- Made from heavy industrial steel, with welded and bolted construction
- Extends from 24" to 33" with spring-loaded lock pins
- 3" heavy-duty ball bearing, non-marring polyurethane wheels make transporting easier and faster



Scan Here FOR PRODUCT INFO



Item No.	Description	Case Qty	Packaging
10-575	Heavy Cargo Dollies (Set of 2)	1	Box

PRO COMFORT KNEE PADS



Specifically designed for installers, Pro Carpet Knee Pads provide cushioning and support to knees.

- 25% increase in strap length, and improved design for fit and durability
- Heavy-duty foam padding conforms to knees, providing stability while kneeling
- Extra-wide padded upper strap lessens impact during knee kicking
- Premium-grade neoprene is comfortable, washable and won't pinch the skin



Item No.	Description	Case Qty	Packaging
79034	Pro Carpet Knee Pads	6	Peggable Hang Card

HARD CAP KNEE PADS



Skateboard-style pads, Hard Cap Knee Pads help prevent knee injury and provide comfort while installing carpet.

- Hard cap glides easily on soft flooring
- Nylon fabric with foam cushion for comfort
- Adjustable hook and loop straps ensures the right fit



Item No.	Description	Case Qty	Packaging
79023-6	Hard Cap Knee Pads	6	Peggable Hang Card

CARPET PULLER



The Carpet Puller is ideal to tear out and remove glued-down carpet (without a pad), double glued-down carpet (with a pad) and stretch-in carpet installations.

- Serrated clamps ensure firm carpet grip, ideal for removing carpet
- Die-cast aluminum provides maximum pulling power
- Large comfortable handle for improved grip



Item No.	Description	Case Qty	Packaging
10-10	Carpet Puller	2	Peg Card

⚠️WARNING: Cancer - www.P65Warnings.ca.gov. See P. 81, *Prop 67 - 2.

PRO MINI PRY BAR

Made of high-carbon forged steel, the Pro Mini Pry Bar is ideal to remove base molding and tack strip.

- 32° angle provides ideal leverage to remove 1" nails
- Deep bevel nail slot for easy nail removal
- Versatile 10½" tool is built to last and small enough to fit in your toolbox



32°
IMPROVED ANGLE

Item No.	Description	Case Qty	Packaging
10-503	Pro Mini Pry Bar	3	Pegged Hang Card

20-OZ. RIPPING HAMMER

Featuring a contoured handle and American hickory construction, the 20 oz. Ripping Hammer provides optimal strength and minimizes impact shock while installing new tack strip.

- Long straight claw is ideal for pulling up old tack strip
- 14" long and 20-oz. head



Item No.	Description	Case Qty	Packaging
10-114	20 oz. Ripping Hammer	6	Printed Carton

HEAVY-DUTY 6" CONVERTIBLE SCRAPER

Rugged and dependable, Heavy-Duty 6" Convertible Scraper with adjustable handle is the ideal tool to remove adhesive, carpet, tile and other flooring materials.

- Easily converts to a stand-up scraper with the addition of a stretcher extension tube (sold separately)
- Action lock handle adjusts 360° to any position
- Comfortable molded handle maximizes thrust and conserves energy

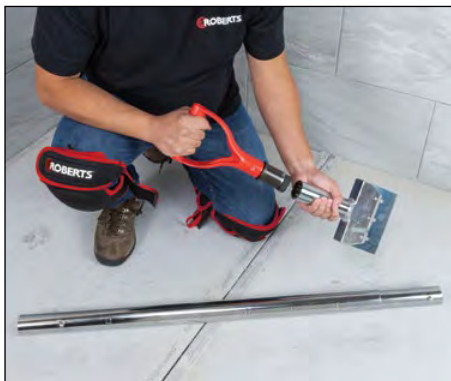

Item No.	Description	Case Qty	Packaging
10-195	Heavy-Duty 6" Convertible Scraper	1	Carton
10-195-01	Replacement: 6" Hardened Steel Blade	1	Carton
10-230-10	Accessory: 3' Steel Stretcher Tube	1	Carton

Scan Here
FOR PRODUCT INFO



4" FLOOR AND WALL SCRAPER & STRIPPER



4" Floor and Wall Scraper & Stripper is the ideal tool for stripping floors and walls, as well remove adhesive, paint and other installation residues.

- Angled head provides "clean shaving" cutting action
- Features three blade clamp screws for maximum blade holding power



Item No.	Description	Case Qty	Packaging
10-194	4" Floor and Wall Scraper & Stripper (12" Handle)	10	Clamshell
10-294	4" Floor and Wall Scraper & Stripper (18" Handle)	10	Clamshell

STAND-UP SCRAPER



The Stand-Up Scraper is ideal to remove old adhesive, vinyl, carpet, tile and other floor covering materials. Sturdy construction with an 8" hardened steel blade.

- Deluxe cushioned grip handle, adjustable from 3' to 6'
- Sturdy construction with an 8" hardened steel blade and locking cam
- 15° angled head reaches underneath toe kicks and other small spaces



Item No.	Description	Case Qty	Packaging
10-296	Stand-Up Scraper	6	Peg Wrap

PRO FLOOR & WALL SCRAPER



The heavy-duty construction of the Pro Floor & Wall Scraper removes tough materials like stubborn glue and old flooring material, leaving surfaces smooth and prepped.

- Ball cap fits in the palm of your hand for comfortable scraping
- Designed for less user fatigue
- Ideal for a variety of wall and floor stripping applications



Item No.	Description	Case Qty	Packaging
10-188	Pro 4" Floor & Wall Scraper (18" Handle)	6	Pegged Hang Card

MOZART WELD ROD TRIMMER



- Includes swiveling MOZART spacer claw, eliminating need for guide plate
- No sharpening needed
- Includes interchangeable, industrially manufactured, economical trimming blades



Item No.	Description	Case Qty	Packaging
10-1600	Mozart Weld Rod Trimmer (Canada Only)	1	Carton
10-8678	Replacement: Mozart Trimmer Blades (5 Pack Card)	10	Carton
10-8679	Replacement: Mozart Trimmer Scraper Claw (0.5 mm)	10	Carton
10-8700	Replacement: Mozart Trimmer Scraper Claw (0.7 mm)	10	Carton
10-041	Replacement: Fixing Attachments (1 Screw & 3 Washers)	10	Carton

Canada Only



FLOOR & WALL SCRAPER BLADES

Floor & Wall Scraper Blades are made of precision ground high speed carbon steel blade for sharpness and durability to yield professional results.

Item No.	Description	Case Qty	Packaging
10-442-10	4" Floor & Wall Scraper Blades (4" long x 0.15" thick) 10 packs of 10 Blades: 100 Blades For use with 10-187, 10-188, 10-194, 10-294 and all standard 4" scrapers	10	Hang Cards
10-458	8" Floor & Wall Scraper Blades (8" long x 0.74" wide x 0.15" thick) 10 packs of 1 Blade: 10 Blades For use with 10-296 and all standard 4" scrapers	1	Peggable Card

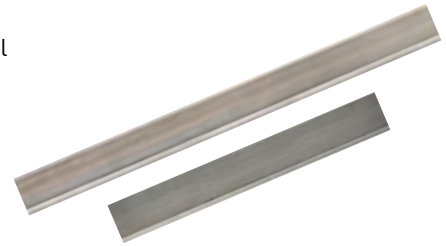

made in
USA

* For Replacement Knife Blades, see page 34. For Replacement Floor Cutter Blades, see page 47.

DELUXE GRIP POUCH



The Deluxe Grip Pouch holds tools firmly in place with special leather insert grips.

- 100% double-stitched leather for extended wear and longer product life
- Slotted to fit directly on a belt
- 7½" x 4½" x 3/4" with one large pocket

Item No.	Description	Case Qty	Packaging
10-260	Deluxe Grip Pouch	12	Pegged Card

made in
USA



CHALK & LINE REEL



The Chalk & Line Reel ensures straight lines and installations on a variety of building applications.

- 100' abrasion-resistant poly line
- Robust steel handle and large center hub for increased durability, strength and torque
- Tear-drop shape for use as a plumb bob

Item No.	Description	Case Qty	Packaging
10-303S	Chalk & Line Reel	6	Carton
10-321	Replacement: White Chalk Refill (8 oz.)	24	Carton



30' TAPE MEASURE



Durable and easy to read, the 30' Tape Measure can be used indoors and outdoors.

- Rugged case with red rubber jacket
- Larger numbers for improved readability
- Strong spring return; thumb lock and steel belt clip
- The 1" blade is steel acrylic coated to ensure durability

Item No.	Description	Case Qty	Packaging
10-140	30' Tape Measure	12	Pegged Card



NEW
AVAILABLE
SPRING '25

Palette

QUICK-REPAIR PUTTY

Ensure the perfect finish on your wood, vinyl or laminate floors with our putties.



- Dries in 30 minutes
- Can be mixed to create new colors
- Easy to paint or sand, and no shrinking
- Low-VOC, environmentally friendly and safe to use
- 2-year shelf life

We're expanding our 'Palette' to meet your evolving needs.

Check out our new on-trend colors!

Gray
PC7728

Dark Brown
PC7732

Brown
PC7725

Tan
PC7730

Greige
PC7740

Natural
PC7741

Black
PC7743

White
PC7742

NEW

NEW

NEW

NEW



WOOD, LAMINATE & VINYL PUTTY



Acrylic based and easy to use, the putty is used to fill gaps, nicks and scratches on wood, laminate and vinyl flooring.

Item No.	Description	Case Qty	Packaging
PC7725	Brown Repair Putty	6	3 oz. Tube
PC7726	Light Repair Putty	6	3 oz. Tube
PC7728	Gray Repair Putty	6	3 oz. Tube
PC7730	Tan Repair Putty	6	3 oz. Tube
PC7732	Dark Brown Repair Putty	6	3 oz. Tube
PC7733	Light Gray Repair Putty	6	3 oz. Tube
PC7740	Greige Repair Putty	6	3 oz. Tube
PC7741	Natural Repair Putty	6	3 oz. Tube
PC7742	White Repair Putty	6	3 oz. Tube
PC7743	Black Repair Putty	6	3 oz. Tube



Made in Canada

Scan Here
FOR PRODUCT INFO



UNIVERSAL REPAIR KIT



The Universal Repair Kit is designed to repair cracks, scratches or other damage to wood floors, vinyl floors and counters, wood cabinets, molding and furniture.

- Features five colors and an empty container for custom mixing to match any project
- Easy to sand and stain
- Quick drying and no shrinking



Item No.	Description	Case Qty	Packaging
10-33	Universal Repair Kit	6	Clamshell



TROWELS

If the goal is spreading thinset or adhesive, we have you covered with notches, trowels featuring rustproof steel blades, die-cast aluminum shanks and contoured handles. Choose from easy grip wood handles, firm grip plastic handles or other adhesive applicators.

WOOD HANDLE TROWELS



High-quality 11" x 4½" trowel with hardened and tempered steel blade and large wooden handle for an easy grip.

- Blade is ground and polished for lasting durability
- Long, die-cast aluminum shank
- First and last rivets reinforced and welded for added durability

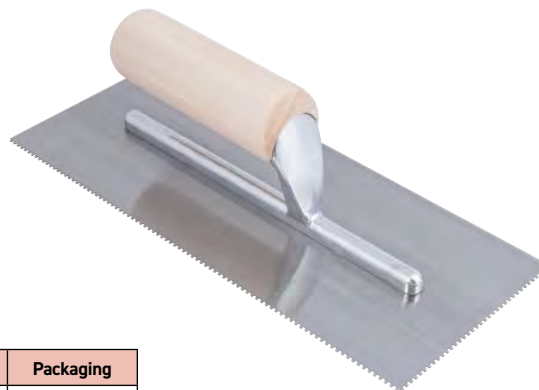

Item No.	Description	Case Qty	Packaging
10-810	1/16" x 1/16" x 1/16" SQ-Notch Trowel (w / 10% Blade Angle)	12	Display Box
49768	1/16" x 1/16" x 1/16" SQ-Notch Trowel	12	Display Box
49730	3/16" x 1/4" x 1/2" Flat Top V-Notch Trowel	12	Display Box
49737	1/8" x 1/8" x 1/16" Flat Top V-Notch Trowel	12	Display Box
49738	1/16" x 1/32" x 5/64" U-Notch Trowel	12	Display Box
49766	1/8" x 1/8" x 1/8" SQ-Notch Trowel	12	Display Box
49767	1/4" x 3/16" Tiger Tooth® V-Notch Trowel	12	Display Box
49769	1/4" x 1/4" x 1/4" Flat Top V-Notch Trowel	12	Display Box
49771	1/16" x 1/32" x 1/32" U-Notch Trowel	12	Display Box
49713 (QEP)	1/4" x 1/4" x 1/4" SQ-Notch Trowel	12	Display Box

ECONOMY NOTCHED TROWELS

Engineered for extended wear and tear, Economy Notched Trowels are designed for application of pressure sensitive, resilient adhesives.

- Cold-rolled 9" steel blade for longer wear
- High-impact, black plastic handle for firm, comfortable grip



Item No.	Description	Case Qty	Packaging
10-181	Economy Dual-Notch Trowel: 1/16" x 1/32" x 1/32" U-Notch Trowel; 1/16" x 1/16" x 1/16" SQ-Notch	12	Display Box
10137	1/8" x 1/8" x 1/8" Economy Flat Top V-Notch Trowel	12	Display Box
10113 (QEP)	1/4" x 1/4" x 1/4" Economy SQ-Notch Trowel	12	Display Box

made in
USA

COVE BASE ADHESIVE SPREADER









Manufactured with a cold-rolled steel blade for durability, the Cove Base Adhesive Spreader is designed to spread adhesive for a flat, well-bonded cove base installation.

- Fits into a 1 qt. canister of adhesive for quicker, easier application
- Wood handle for comfort
- Features 3/16" x 5/32" V-Notch

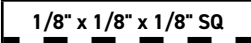
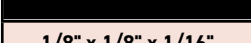

Item No.	Description	Case Qty	Packaging
10033	Cove Base Adhesive Spreader	24	Label & Display Box

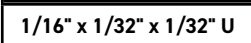
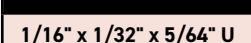
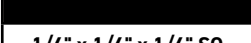
FOR CARPET, VINYL SHEET, LVT, VCT & WOOD

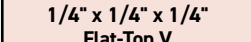
Notch Size	Application	Wood Handle (11" Blade)	Economy
1/16" x 1/16" x 1/16" SQ 	For carpet tile, fiberglass sheet, felt-backed sheet, luxury vinyl tile, plank, and cork underlayment	49768	10-181*
1/16" x 1/16" x 1/16" SQ 	For carpet tile, fiberglass sheet, felt-backed sheet, luxury vinyl tile and plank	10-810 (with 10° blade angle)	
1/8" x 1/8" x 1/8" SQ 	For pre-finished parquet and wall base	49766	
1/8" x 1/8" x 1/16" Flat-Top V 	For secondary-backed carpet, direct glue-down, sheet vinyl installations, and cork underlayment	49737	10137-12
1/16" x 1/32" x 1/32" U 	For VCT, vinyl, luxury vinyl tile and plank	49771	10-181*
1/16" x 1/32" x 5/64" U 	For carpet tile, fiberglass sheet, felt-backed sheet, and VCT	49738	
1/4" x 1/4" x 1/4" SQ 	For thinset application of ceramic tile 8" x 8" or smaller, laminated wood plank flooring, flat milled solid & shorts or plywood	49713 (QEP)	10113 (QEP)
1/4" x 1/4" x 1/4" Flat-Top V 	For pre-finished engineered wood plank, solid wood, bamboo and acrylic impregnated plank flooring	49769	
1/4" x 3/16" Tiger Tooth® 	For bamboo, solid and engineered wood flooring up to 1/2 in. thick	49767	
3/16" x 1/4" x 1/2" Flat-Top V 	For laminated wood plank, solid wood, bamboo and acrylic impregnated plank flooring	49730	

*** Double Sided Trowels**

Always check adhesive/mortar manufacturer's trowel recommendations before selecting a trowel notch.

All trowels measure: width x depth x space apart

Recommended notch sizes by NTCA (National Tile Contractors Association)

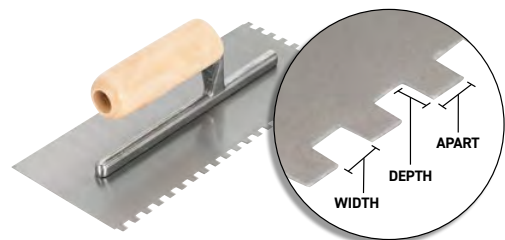

SNOZZLE ADHESIVE APPLICATOR

The SNOZZLE Adhesive Applicator creates a flat, well-bonded installation by spreading 11 rows of adhesive at a time.

- Compatible with 11 oz. and 30 oz. adhesive cartridges and fits most standard applicator guns
- Distributes adhesive in tight spaces where a standard trowel can't be used
- Ideal for cove base or flooring plank repair



made in USA

Item No.	Description	Case Qty	Packaging
10-981-25	Snozzle Adhesive Applicator	25	Hang Tag & Display Box
10-981	Canada Only: Snozzle Adhesive Applicator	25	Pegged Hang Tag



UNDER LAYMENTS

Indispensable to protecting your floors against moisture, mold and mildew damage, ROBERTS® underlayments provide a layer of cushioning to the floors, reduce subfloor imperfections, and quiet footfalls and ambient noise, adding years of use and enjoyment to your floors.

FIRST STEP® PREMIUM UNDERLAYMENT

For use under floating laminate and engineered hardwood flooring, sound resistant First Step® Premium Underlayment can be used above, below and on grade subfloors.



#1 BEST OVERALL LAMINATE
UNDERLAYMENT FOR 2024*

Source: bobvilla.com

Featuring Air Flow Technology

Air ventilation fights damage caused by trapped moisture

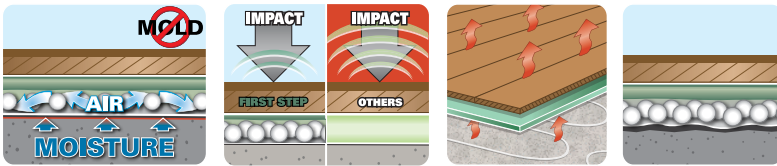

- 3-layer design has polystyrene beads to allow moisture to flow to the exterior to be expressed safely
- Adhesive strip and 4" overlap film help join pieces and lock out moisture
- 2-mil top-layer protects finished floor from subfloor moisture
- Outstanding compression resistance and mold / mildew defense
- Reduces ambient noise and helps level minor subfloor imperfections
- Ideal in condos and multi-level dwellings

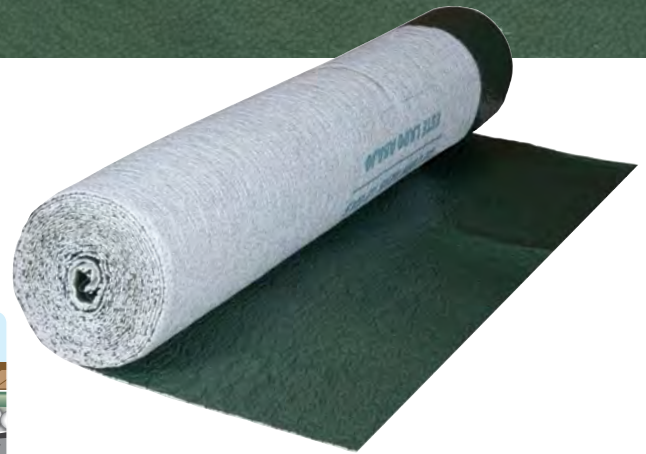

Applications:

RESIDENTIAL & COMMERCIAL

Approved Substrates:

- CONCRETE SUBFLOORS
- WOOD SUBFLOORS

Approved for Use Under:

- LAMINATE FLOORING
- HARDWOOD FLOATING FLOORS

Locations:

BELOW-GRADE, ON-GRADE, & ABOVE-GRADE

First Step
PREMIUM UNDERLAYMENT



Thickness	IIC Rating*	STC Rating*	Δ Rating*	R-Value
2 mm	68	67	20	0.432

Item No.	Description	Case Qty	Packaging
70-102-12	First Step® Premium (100 sq. ft. roll) 40" x 30'	12	Corrugate
70-102-1	First Step® Premium (630 sq. ft. roll) 40" x 189'	1	Polybag

made in
USA

Scan Here
FOR PRODUCT INFO



QUIET CUSHION®



Comprised of extra fine, cross-linked foam for superior sound reduction, advanced moisture protection and improved shock absorption. Quiet Cushion® is ideal for use under engineered and laminate flooring.

- Anti-crush technology for excellent performance and long life
- Adhesive strip and 3" overlap film help join pieces and lock out moisture
- Excellent for radiant heat floors, mold and mildew resistant

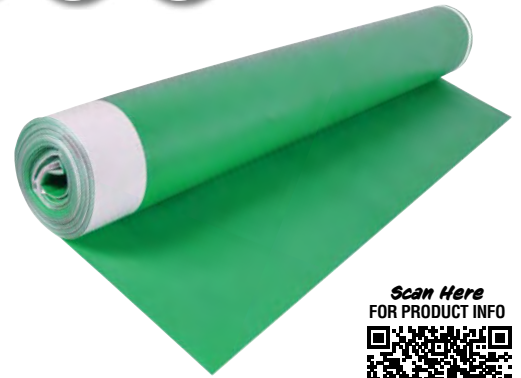

Thickness	IIC Rating*	STC Rating*	Δ Rating*	R-Value
2 mm	71	67	21	0.253

Item No.	Description	Case Qty	Packaging
70-180	Quiet Cushion® Underlayment (100 sq. ft. roll) 43.5" x 27.5'	12	Corrugate

BLACK JACK®



Ideal for use above, below and on grade under laminate and engineered wood flooring. Black Jack® is made of dense, closed cell foam.

- Dense, closed cell structure offers moisture, mold and mildew resistance
- Adhesive strip and 3" overlap film help join pieces and lock out moisture
- Ideal for use over radiant heated floors



Thickness	IIC Rating*	STC Rating*	Δ Rating*	R-Value
2.5 mm	70	66	21	0.425

Item No.	Description	Case Qty	Packaging
70-026	Black Jack® Underlayment (100 sq. ft. roll) 43" x 28'	12	Corrugate
70-026XL	Black Jack® Underlayment (600 sq. ft. roll) 43" x 167.5'	2	Corrugate

SOFT STRIDE®



Soft Stride® is a dense foam underlayment that provides excellent sound reduction under laminate and engineered flooring.

- Closed cell foam design provides excellent moisture protection and fights against mold and mildew
- Excellent for radiant floors and ambient sound reduction
- Adhesive strip and 3" overlap film help join pieces and lock out moisture



Thickness	IIC Rating*	STC Rating*	Δ Rating*	R-Value
2 mm	69	66	21	0.343

Item No.	Description	Case Qty	Packaging
70-185	Soft Stride® Underlayment (100 sq. ft. roll) 43.5" x 27.5'	12	Corrugate

* IIC measures sound such as moving furniture and walking, STC measures sound such as voices and television. Minimum sound rating required by most building codes and architects is 50. R-Value is the rating used to measure resistance to heat flow. Δ Delta Rating is the only true measurement of sound reduction from a product (not a floor assembly) in the industry.

SUPER FELT®



For use under laminate and engineered wood flooring. Super Felt® provides premium R-Value to take the chill out of cold floors.

- 2-mil top film protects against exposure to harmful vapors and minimizes the growth of mold and mildew
- Made with 80% recycled fibers to absorb sound and minimize noise
- Adhesive strip and 3" overlap film help join pieces and lock out moisture



Scan Here FOR PRODUCT INFO



Thickness	IIC Rating*	STC Rating*	Δ Rating*	R-Value
3 mm	67	66	21	0.58

Item No.	Description	Case Qty	Packaging
70-190	Super Felt® Underlayment (100 sq. ft. roll) 44" x 27.3'	1	Polybag
70-193	Super Felt® Underlayment (360 sq. ft. roll) 44" x 98'	1	Polybag

UNISON® 2-IN-1



Unison 2-in-1® is ideal for use with laminate and engineered wood flooring. Made of 3/32" thick polyethylene foam with a top film.

- Top film protects from harmful moisture barrier
- Adhesive strip and 4" overlap film help join pieces and lock out moisture



Scan Here FOR PRODUCT INFO



Thickness	IIC Rating*	STC Rating*	R-Value
3/32"	61	54	0.29

Item No.	Description	Case Qty	Packaging
70-025	Unison® 2-in-1 Underlayment (100 sq. ft. roll) 48" x 25'	12	Corrugate

SERENITY FOAM



Ideal for use under laminate and engineered wood flooring. Serenity features a 3/32" thick polyethylene foam to provide cushioning between floors or subfloors.

- Adds cushioning and compensates for minor imperfections in the subfloor
- Can be used in above-grade installations and in conjunction with a moisture barrier for below grade
- Easy to roll out for fast installation



Scan Here FOR PRODUCT INFO



Item No.	Description	Case Qty	Packaging
70-010	Serenity Foam Underlayment (100 sq. ft. roll) 48" x 25'	60	Corrugate
70-010-XL	Serenity Foam Underlayment (400 sq. ft. roll) 48" x 100'	1	Corrugate

made in USA

* IIC measures sound such as moving furniture and walking, STC measures sound such as voices and television. Minimum sound rating required by most building codes and architects is 50. R-Value is the rating used to measure resistance to heat flow. Δ Delta Rating is the only true measurement of sound reduction from a product (not a floor assembly) in the industry.

SOUND BARRICADE



Comprised of a crushed-proof rubber blend, Sound Barricade is designed for use under vinyl, laminate or wood flooring in floating, nail-down, staple or double glue-down installations.

- Rubber blend inhibits the growth of mold and mildew
- Rubber foam technology provides superior acoustical properties
- Retains cushion and shape through the use of recycled tire crumb materials
- Can be used for floating, nail down, staple or double-glue down installations



Flooring	Thickness	IIC Rating*	STC Rating*	Δ Rating*	R-Value*
LVT & Planks	1.5 mm	69	63	25	0.205
Laminate & Wood	1.5 mm	68	63	22	0.205

Item No.	Description	Case Qty	Packaging
70-197	Sound Barricade (200 sq. ft. roll) 36" x 66'	1	Polybag



Scan Here FOR PRODUCT INFO



MOISTURE BARRICADE



Moisture Barricade is designed for use with laminate and engineered wood flooring underlayments to provide superior moisture protection.

- 6-mil thick to stop moisture from reaching finished floors
- NWFA required class one moisture barrier over cement slabs
- Features an adhesive strip to lockout moisture
- Required for use with SPC flooring on, above or below grade

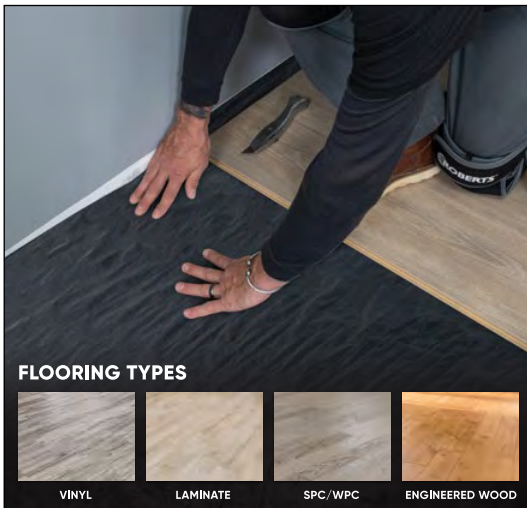

Item No.	Description	Case Qty	Packaging
70-115	Moisture Barricade (120 sq. ft. Roll) 10' x 12' roll	12	Label
70-116	Moisture Barricade (300 sq. ft. Roll) 12' x 25' roll	6	Label
70-117	Moisture Barricade (600 sq. ft. Roll) 12' x 50' roll	1	Label
70-118	Moisture Barricade (1000 sq. ft. Roll) 12' x 83.3' roll	1	Label

Scan Here FOR PRODUCT INFO



* **IIC** measures sound such as moving furniture and walking, **STC** measures sound such as voices and television. Minimum sound rating required by most building codes and architects is 50. **R-Value** is the rating used to measure resistance to heat flow. **Δ Delta Rating** is the only true measurement of sound reduction from a product (not a floor assembly) in the industry.

SILICONE MOISTURE BARRIER



Silicone Moisture Barrier meets the perm ratings recommendation by the National Wood Flooring Association for staples and nail-down installations of solid and engineered wood floors.

- For use over wood subfloors
- Reduces vapor flow without trapping moisture
- Can be used with radiant heat systems—no asphalt odor



Scan Here
FOR PRODUCT INFO



Item No.	Description	Case Qty	Packaging
70-198	Silicone Moisture Barrier (200 sq. ft. Roll) 33.5" x 72"	6	Label

AQUABAR® "B" MOISTURE VAPOR BARRIER



Aquabar® "B" Underlayment is extremely effective in protecting against moisture damage. Recommended for use beneath wood flooring, ceramic, and stone veneer, or as a membrane on walls and countertops.

- Slows moisture migration, prevents flooring from buckling, cupping or cracking
- Meets CA01350 indoor air quality standards



Item No.	Description	Case Qty	Packaging
70-195	Aquabar® "B" Moisture Vapor Barrier (500 sq. ft. roll) 36" x 167"	1	Polybag

WAXED PAPER ROLL UNDERLAYMENT



Waxed Paper Roll is recommended for the installation of hardwood and engineered nail-down flooring. Ideal for reducing squeaks in wood floors.

- Used as a barrier between wood subfloor and new floor on above grade installations
- Helps slides boards into place with ease



Item No.	Description	Case Qty	Packaging
70-120	Waxed Paper Roll (750 sq. ft. roll) 36" x 250"	1	Polybag

NATURAL CORK UNDERLAYMENT

Environmentally-friendly cork underlayment is naturally hypoallergenic and contributes to a healthier indoor air quality.



- Quiets footfalls, as well as sound transfer from floor to living spaces below
- Helps prevent the transfer of stress cracks from the subfloor to flooring surface
- Ideal for use with radiant heat systems
- Use under ceramic tile, stone, marble, engineered wood and laminate floors
- Can be used in floating and glue-down floor installations



Flooring	Thickness	IIC Rating*	STC Rating*	Δ Rating*
w / 6" cement slab and suspended ceiling	1/4" (6 mm)	74	70	22

Item No.	Description	Case Qty	Packaging
72000Q	1/4" Natural Cork (200 sq. ft. roll) 48" x 50'	1	Polybag
72003Q	1/4" Natural Cork (100 sq. ft. roll) 48" x 25'	1	Polybag
70-175	1/4" Natural Cork (300 sq. ft. sheets) 2' x 3'	50	Carton
72001Q	1/2" Natural Cork (150 sq. ft. sheets) 2' x 3'	25	Carton

Scan Here FOR PRODUCT INFO



Scan Here FOR PRODUCT INFO



Scan Here FOR PRODUCT INFO



* IIC measures sound such as moving furniture and walking, STC measures sound such as voices and television. Minimum sound rating required by most building codes and architects is 50. R-Value is the rating used to measure resistance to heat flow. Δ Delta Rating is the only true measurement of sound reduction from a product (not a floor assembly) in the industry.



SPECIALTY TAPES

Quickly repair loose vinyl moldings, secure slipping carpets / rugs / treads, or complete household projects with our assortment of specialty tapes.

UNDERLAYMENT SEAM TAPE



Underlayment Seam Tape is ideal for joining underlayment seams under floating floors and for repairing rips during underlayment installation.

- PVC tape provides protection against moisture damage to floors
- Compatible with all brands of underlayment
- Multipurpose and versatile, tape can be used for carpet padding seams, sealing boxes and much more
- Ribbed for easier tearing



Item No.	Description	Case Qty	Packaging
50-040	Underlayment Seam Tape (1-7/8" x 100' Roll)	12	Printed Box

⚠WARNING: Cancer and Reproductive Harm- www.P65Warnings.ca.gov. See P. 81, *Prop 65 - 1.

MAX GRIP® VINYL FLOOR INSTALLATION TAPE



For permanent installation of vinyl flooring, wall base, stair, tread and vinyl trim.

- Ideal for modified loose lay vinyl sheet flooring installation and flooring repairs
- Heavy-duty adhesive with reinforced scrim webbing instantly bonds with no clean-up required
- For indoor use, adheres to clean and dry subfloors



Item No.	Description	Case Qty	Packaging
50-540	Max Grip® Vinyl Flooring Installation Tape (1-7/8" x 50')	12	Retail Box and Display Box

MAX GRIP® CARPET INSTALLATION TAPE



For the permanent installation of carpet, moldings and trim. Max Grip® Carpet Installation Tape features an aggressive acrylic adhesive for maximum holding power.

- Ideal for modified loose stair, treads and flooring repairs
- For indoor and outdoor installations

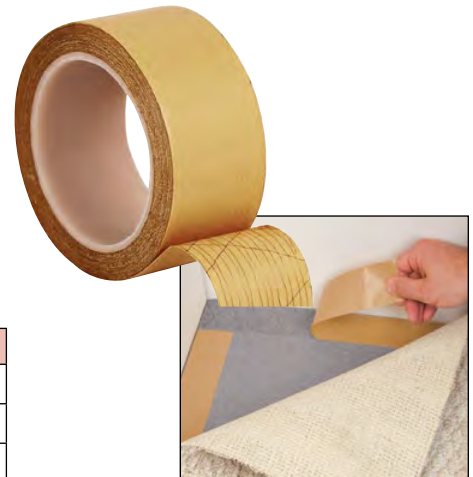

Item No.	Description	Case Qty	Packaging
50-550	Max Grip® Carpet Installation Tape (1-7/8" x 75')	12	Retail Box and Display Box
50-560	Home Easy Carpet Installation Tape (1" x 164')	6	Individual Wrap / Corrugate
50-565	Max Grip® Carpet Installation Tape (3" x 164')	3	Individual Wrap / Corrugate

TREAD TAPE

Anti-slip safety strip, Tread Tape provides extra traction on stairs, loading docks and ladders. Coarse, grit sandpaper surface helps prevent slipping and falling.



Item No.	Description	Case Qty	Packaging
50-585	Tread Tape Roll (2" x 15')	6	Printed Box

DUCT TAPE

Duct Tape is ideal for HVAC duct work, temporary repairs, and household use.

- Great for general repairs, projects, packing, seaming and sealing
- Pressure sensitive adhesive bonds quickly when pressed in place
- Easily tears by hand



Item No.	Description	Case Qty	Packaging
50-555	Duct Tape (1-7/8" x 60 yards)	36	Printed Box

RUG GRIPPER™ TAPE



Rug Gripper™ offers non-slip strength to keep your rugs and mats from bunching up or sliding across the floor on tile, marble, laminate, wood and carpet. This is an anti-slip tape for indoor use.

- Safe for all floor surfaces including carpet
- Removable and repositionable

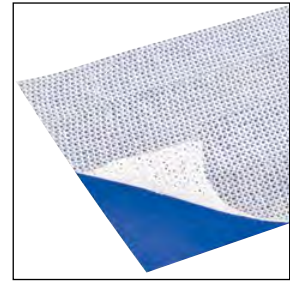

Item No.	Description	Case Qty	Packaging
50-580	Rug Gripper™ Tape Roll (2½" x 25')	6	Printed Box
50-588	Rug Gripper™ Tape Roll (3" x 60')	6	Printed Box

STAY 'N' PLACE® TAPE TABS

Featuring a unique dual adhesive technology, Stay 'N' Place® tabs prevent your rug corners from curling.

- Helps prevent rugs and mats (3' x 5') from moving and slipping
- Anti-skid tabs are safe to use on different hard floor surfaces
- Removable and repositionable



Item No.	Description	Case Qty	Packaging
50-547	Stay 'N' Place® Tabs 4-Pack (4" x 4")	24	Printed Sleeve

RUG TRACTION™ ANTI-SLIP RUBBER TAPE

Specifically designed with a non-slip strip for holding mats in place. Rug Traction™ Anti-Slip Rubber Tapes are easy to apply and require no clean up.

- Prevents slipping, curling and bunching, keeping rugs and mats looking neat and tidy
- Rubber composition and texture delivers great grip and top traction
- Can be cut to size, to provide better positioning and as much grip as needed



Item No.	Description	Case Qty	Packaging
50-545	Rug Traction™ Anti-Slip Rubber Tape (2½" x 25')	12	Printed Box



MERCHANDISING

Increase profitability and generate more sales with numerous merchandising options. Tabletop / retail counter displays and in aisle / end cap displays allow you to feature adhesive cartridges and wood putty repair SKUs. Rugged, 4' gondola showcases top-selling tool assortments or can be customized to suit your merchandising needs.

4' CARPET, VINYL & LAMINATE TOOL MERCHANDISING DISPLAY

FREE display with the purchase of top selling tools.

- Designed and merchandised to deliver incremental sales at high margins
- Included header is adjustable and measures 48" wide x 10" tall
- Display measures 48" wide x 26" deep x 72" high
- Two 4' displays can be combined to create an 8' display



**\$500
VALUE**

FLOORING PUTTY COUNTERTOP DISPLAY

FREE display with the purchase of top selling tools.

- Included header measures 8 1/2" wide x 3 1/2" tall
- Display measures 8 1/2" wide x 10-1/32" deep and 20-1/8" high



**\$70
VALUE**

Item# CTDPUTTYRACK
Sign# CTDPUTTYSIGN

FLOORING PUTTY IN-AISLE DISPLAY

FREE display with the purchase of top selling tools.

- Included headers measures 6 1/2" wide x 1 1/2" tall
- Display measures 7 1/2" wide x 6 1/2" deep and 26 1/2" high



**\$80
VALUE**

Item# 3TRPUTTYRACK
Sign# 3TRPUTTYSIGN

See your sales rep for more details!

10 OZ. ADHESIVE CARTRIDGE COUNTERTOP DISPLAY

FREE display with the purchase of top selling tools.

- Included header measures 11.596" wide 3-1/8" tall
- Display measures 11.596" wide 16.750" deep and 8.858" high



**\$76
VALUE**

Item# CTD12X9,100Z
Sign# CTD12X9SIGN

10 OZ. ADHESIVE CARTRIDGE IN-AISLE DISPLAY

FREE display with the purchase of top selling tools.

- Included header measures 5" wide x 3½" tall
- Display measures 5" wide x 5" deep and 41" high



**\$96
VALUE**

Item# 3TB41X5, 100Z
Sign# 3TB41X5SIGN

30 OZ. ADHESIVE CARTRIDGE COUNTERTOP DISPLAY

FREE display with the purchase of top selling tools.

- Included header measures 5.88" wide 3-1/8" tall
- Display measures 5.88" wide 7.16" deep and 56.77" high



**\$92
VALUE**

Item# CTD16X9,300Z
Sign# CTD16X9SIGN

30 OZ. ADHESIVE CARTRIDGE IN-AISLE DISPLAY

FREE display with the purchase of top selling tools.

- Included header measures 6" wide 5½" tall
- Display measures 6" wide x 6" deep and 57" high



**\$85
VALUE**

Item# 3TB56X6, 300Z
Sign# 3TB56X6SIGN

FLOOR DISPLAYS

Corrugated floor displays are available. See your sales rep for options.



See your sales rep for more details!

ICON LEGEND

	Based on sales over the last 12 months
	This product includes a 1 year warranty which must be registered online at robertsconsolidated.com
	This product includes a 2 year warranty which must be registered online at robertsconsolidated.com
 	A patent has been filed (or is pending) for this product's design or parts
	This product is backed by a limited-lifetime warranty, provided it was installed by a qualified installer following manufacturer installation instructions and requirements
	This SKU features multiple products
	This product features a custom carry case
	This product features components that can be adjusted
	Uses carpet blades
	Uses utility blades
	Uses hooked blades
	Uses hawk blades
	Provides straight cuts on planks
	Provides diagonal cuts on planks
	Replacement parts available

UNDERLAYMENT ICON LEGEND



MOISTURE PROTECTION

Unique qualities or characteristics provide varying levels of moisture protection from basic moisture resistance to superior moisture vapor defense.



RECYCLED

Features materials that have been recycled or may be recycled.



MOLD & MILDEW DEFENSE

Moisture-resistance qualities provide protection against the growth of mild, mildew and odor-causing bacteria



CUSHIONING & LEVELING

Superior craftsmanship / product design provides qualities that resist compression, support and protect locking systems, absorb shock to improve cushioning, and level minor subfloor imperfections.



RADIANT HEAT

Ideal for use with radiant heating floors. Its inclusion helps to remove some of the chill from floors in the winter.



EASE OF INSTALLATION

Adhesive strip and overlap film links multiple rolls and helps ensure superior moisture barrier.



SOUND CONTROL

Product's construction provides superior sound reduction. Sound ratings are measured as IIC, STC, or Delta. IIC measures sound such as moving furniture and walking, STC measures sound such as voices and television. Minimum IIC and STC sound rating requirement is 50 according to the International Building Code.

INDEX *By Item Number*

Item #	Description	Pg.	Item #	Description	Pg.	Item #	Description	Pg.
10-018	The Maverick® Wide Angle Pull Bar	51	10-123	10" Carpet Shears	27	10-237V	Junior Power Carpet Stretcher Value Kit	10
10-041	Replacement: Fixing Attachments	58	10-124	6" Pro Cut Pile Carpet Seam Roller	21	10-237-50	Replacement: Stretcher Head	10
10-10	Carpet Puller	56	10-128	Locking Pattern Matching & Seam Repair Stretcher	12	10-42	Falcon Power 44™ Nap Grip Head	11
10-18-8	Pro Pull Bar	51	10-140	30' Tape Measure	23, 59	10-248	Nap Grip Head	11
10-25	Universal Tapping Block	49	10-146-3	Cushion Back Carpet Cutter	23	10-250	Adjustable Locking Tube	11
10-26	Flooring Installation Kit (30 Wedge Spacers)	49	10-146GT	Golden Touch Cushion Back Carpet Cutter	23	10-252	Professional Carpet Knife	29
10-27	Expansion Joint Wedge Spacers	49	10-148	Cushion Back Carpet Cutter	23	10-253	Carpet Knife	30
10-28	Flooring Installation Kit (50 Wedge Spacers)	49	10-151	Nail Driving Bar	37	10-254	Power-Lok Carpet Stretcher Standard Kit	10
10-33	Universal Repair Kit	61	10-152-3	Loop Pile Cutter	23, 26	10-254V	Power-Lok Carpet Stretcher Value Kit	10
10-35	8" Laminate & Vinyl Plank Cutter	47	10-152GT	Golden Touch Loop Pile Cutters	26	10-254-50	Replacement: Stretcher Head	10
10-36	4-in-1 Expansion Joint Spacers	48	10-154-3	Universal Seam Cutter	27	10-258	Power Stretcher Tail	11
10-42	4 1/4" 20-Tooth Carbide-Tipped Saw Blade	33	10-163	24" Steel Tool Box	22	10-259	Pro Dual-Depth Carpet Knife	29
10-43	Pro Flooring Installation Kit	48	10-181	Dual Notch Economy Trowel	63, 64	10-260	Deluxe Grip Pouch	23, 59
10-46	Super Six 6" Jamb Saw	33	10-188	Pro 4" Floor & Wall Scraper	58	10-279	Topset Gouge	41
10-47-2	6-3/16" 36-Tooth Carbide-Tipped Saw Blade	32, 33	10-194	4" Floor and Wall Scraper & Stripper (12" Handle)	58	10-282G-2	Deluxe Heat Bond Iron	19
10-47-6	6-3/16" 20-Tooth Carbide-Tipped Saw Blade	32, 33	10-195	Heavy-Duty 6" Convertible Scraper	57	10-284	Falcon Power 44™ Stretcher Standard Kit	8, 9
10-49	Double Tap® Reversible Tapping Block	50	10-195-01	Replacement: 6" Hardened Steel Blade	57	10-284V	Falcon Power 44™ Stretcher Value Kit	8, 9
10-55-24	6" Durable Masonry Blade	32, 33	10-215	Razor Blade Knife	30	10-284-40	Empty Falcon Power 44™ Stretcher Case w/ Wheels	11
10-56	Longneck Plus 6" Jamb Saw	32	10-216	3-IN-1 Carpet, Vinyl & Utility Knife	23, 28	10-284-50	Replacement: Falcon Power 44™ Stretcher Head	8, 9
10-60	9" Multi-Floor Cutter	46	10-218F	Big Fatso Multipurpose Knife	30	10-286G	6" Heat Bond Seaming Iron	19
10-63	13" Multi-Floor Cutter	46	10-220	Cut & Jam Carpet Knife	30	10-294	4" Floor and Wall Scraper & Stripper (18" Handle)	58
10-101	4.5" Deluxe Carpet Seam Roller	21	10-221	Pro Utility Knife	31	10-296	Stand-Up Scraper	58
10-107-03	Replacement: Tail Blade Unit	12	10-230-10	3' Steel Stretcher Tube	11, 57	10-303S	Chalk Reel	23, 59
10-108	Professional 2" Strip Cutter	23, 37	10-230-3K	Tube Case with Three 3' Extension Tubes	11	10-321	Replacement: White Chalk Refill	23, 59
10-109	Staple Hammer	18, 23	10-230-40	Empty Stretcher Case with Wheels	11	10-404	Hawk Utility Blades	34
10-114	20-oz. Ripping Hammer	23, 57	10-235-05	5' Aluminum Stretcher Tube	11	10-410	Adjustable Knee Kicker	15
10-117-04	Replacement: Power Head Unit	12	10-235-10	3' Aluminum Stretcher Tube	11	10-412BKK	Deluxe Knee Kicker (Black)	14
10-121	8" Napping Shears	27	10-237	Junior Power Carpet Stretcher Standard Kit	10	10-412-09	Replacement: Bumper Pad (2" thick)	14, 15

Item #	Description	Pg.	Item #	Description	Pg.	Item #	Description	Pg.
10-412-2	Deluxe Knee Kicker (Silver)	14, 23	10-981-25	Snuzzle Adhesive Applicator	64	70-193	Super Felt® Underlayment (360 sq. ft. roll)	68
10-422-09	Replacement: Bumper Pad (3" thick)	14, 15	10-981	Snuzzle Adhesive Applicator (Canada Only)	64	70-195	Aquabar® "B" Moisture Vapor Barrier	70
10-422BK	Deluxe High-Profile Knee Kicker	14	10-990	Replacement: 18" Tungsten Carbide Blade	47	70-197	Sound Barricade Underlayment	69
10-439	Replacement: 6 Strip Cutter Blades	34	10-997	18" PrecisionCuts™ Pro Multi-Floor Cutter	44, 45	70-198	Silicone Moisture Barrier (200 sq. ft. Roll)	70
10-440	Hooked Blades	34	10-1600	Mozart Weld Rod Trimmer (Canada Only)	58	10113 (QEP)	1/4" x 1/4" x 1/4" SQ-Notch Economy Trowel	63, 64
10-442-10	Replacement: 4" Floor & Wall Scraper Blade	59	10-2100	The General® Knee Kicker	13	10137-12	1/8" X 1/16" Flat-Top V-Notch Economy Trowel	63, 64
10-458	Replacement: 8" Floor & Wall Scraper Blade	59	10-8678	Replacement: Mozart Trimmer Blades (5 Pack Card)	58	30002	Quik-Cut Vinyl Tile Cutter	41
10-460	Replacement: 9" Blades for 10-60	45	10-8679	Replacement: Mozart Trimmer Scraper Claw (0.5 mm)	58	49713 (QEP)	1/4" x 1/4" x 1/4" SQ-Notch Wood Handle Trowel	63, 64
10-463	Replacement: 13" Blades for 10-63	46, 47	10-8700	Replacement: Mozart Trimmer Scraper Claw (0.7 mm)	58	49730	3/16" X 1/4" X 1/2" Flat-Top V-Notch Wood Handle Trowel	63, 64
10-468	Replacement: 25" Blades for 10-95	47	20-1450	Smooth Edge Peel & Stick Carpet Tack Strip (3-pk)	37	49737	1/8" x 1/8" x 1/16" Flat-Top V-Notch Wood Handle Trowel	63, 64
10-482G	Cool Shield® Heat Bond Iron	19	30-110	3/8" Chisel Point Staples (5000/box)	18	49738	1/16" x 1/32" x 5/64" U-Notch Wood Handle Trowel	63, 64
10-485	Dual Air Glider	54, 55	33-100	5/8" Concrete Nails (1 lb. bag)	37	49766	1/8" x 1/8" x 1/8" SQ-Notch Wood Handle Trowel	63, 64
10-501	Golden Touch® Carpet Knee Kicker	14	50-040	Underlayment Seam Tape	73	49767	1/4" x 3/16" Tiger Tooth Wood Handle Trowel	63, 64
10-503	Pro Mini Pry Bar	23, 57	50-540	Max Grip® Vinyl Flooring Installation Tape	73	49768	1/16" x 1/16" x 1/16" SQ-Notch Wood Handle Trowel	63, 64
10-517	Row Finder & Separator	23, 24	50-545	Rug Traction™ Anti-Slip Rubber Tape	74	49769	1/4" x 1/4" 1/4" Flat-Top V-Notch Wood Handle Trowel	63, 64
10-521	Pro Stair Tool	23, 24	50-547	Stay 'N' Place® Tabs 4-Pack	74	49915 (QEP)	1/4" x 1/4" x 1/4" SQ-Notch Comfort Grip Trowel	63, 64
10-522-4	EZ TUK® Carpet Tucker	23, 24	50-550	Max Grip® Carpet Installation Tape (1-7/8" x 75')	73	49771	1/16" x 1/16" x 1/16" SQ-Notch Wood Handle Trowel	63, 64
10-575	Heavy Cargo Dollies (Set of 2)	56	50-555	Duct Tape (1-7/8" x 60 yards)	74	61613	White Rubber Mallet	23
10-585	6" Duckbill Napping Shears	27	50-560	Max Grip® Carpet Installation Tape (1" x 164')	73	72000Q	Natural Cork (200 sq. ft. Roll)	71
10-586-3	7" Duckbill Napping Shears	23, 27	50-565	Max Grip® Carpet Installation Tape (3" x 164')	73	72001Q	Natural Cork Sheets (25-pk)	71
10-600	Professional Electric Stapler	18	50-580	Rug Gripper Tape Roll (2½" x 25')	74	72003Q	Natural Cork (100 sq. ft. Roll)	71
10-610	PowerTak™ Electric Tacker	16, 17	50-585	Tread Tape Roll (2' x 15')	73	79023-6	Hard Cap Knee Pads	56
10-616-2A	Conventional Carpet Trimmer	23, 26	50-588	Rug Gripper Tape Roll (3" x 60')	74	79034	Pro Carpet Knee Pads	56
10-617GT	Golden Touch® Carpet Trimmer	26	70-010	Serenity Foam Underlayment (100 sq. ft. roll)	68	110013	Divergent Point Staples	18
10-752	Deluxe Carpet Installation Kit	23	70-010-XL	Serenity Foam Underlayment (400 sq. ft. roll)	68	PC7725	Brown Repair Putty	60, 61
10-810	1/16" x 1/16" x 1/16" SQ-Notch Wood Handle Trowel	63, 64	70-025	Unison® 2-in-1 Underlayment	68	PC2226	Light Repair Putty	60, 61
10-823	1/16" x 1/16" x 1/16" SQ-Notch Comfort Grip Trowel	63, 64	70-026	Black Jack® Underlayment (100 sq. ft. roll)	67	PC7728	Gray Repair Putty	60, 61
10-895	12" Vinyl Tile Cutter	42	70-026-XL	Black Jack® Underlayment (600 sq. ft. roll)	67	PC7730	Tan Repair Putty	60, 61
10-900	12" Pro Vinyl Tile Cutter	42	70-102-1	First Step® Premium (630 sq. ft. roll)	66	PC7732	Dark Brown Repair Putty	60, 61
10-905	Multipurpose Wall Trimmer	26	70-102-12	First Step® Premium (100 sq. ft. roll)	66	PC7733	Light Gray Repair Putty	60, 61
10-910	Replacement: 9" Blades for 10-91	45	70-115	Moisture Barricade (120 sq. ft. roll)	69	PC7740	Greige Repair Putty	60, 61
10-911	9" PrecisionCuts™ Pro Multi-Floor Cutter	44, 45	70-116	Moisture Barricade (300 sq. ft. roll)	69	PC7741	Natural Repair Putty	60, 61
10-918	18" Pro Vinyl Tile Cutter	42	70-117	Moisture Barricade (600 sq. ft. roll)	69	PC7742	White Repair Putty	60, 61
10-920-6	Pro Fixed-Blade Knife	31	70-118	Moisture Barricade (1,000 sq. ft. roll)	69	PC7733	Black Repair Putty	60, 61
10-925	Pro Vinyl Flooring Knife	23, 31	70-120	Waxed Paper Roll	70			
10-935	35 lb. Vinyl & Linoleum Flooring Roller	41	70-127-3	Carpet Rake & Groomer	24			
10-940	Replacement: 13" Tungsten Carbide Blade	47	70-175	Natural Cork Sheet (50-pk)	71			
10-942	13" PrecisionCuts™ Pro Multi-Floor Cutter	44, 45	70-180	Quiet Cushion® Underlayment	67			
10-950	75 lbs. Heavy-Duty Flooring Roller	20	70-185	Soft Stride® Underlayment	67			
10-952	100 lbs. Heavy-Duty Flooring Roller	20	70-190	Super Felt® Underlayment (100 sq. ft. roll)	68			
10-952-04	Replacement: Transport Wheel Assembly Kit	20, 41						
10-959	25" PrecisionCuts™ Pro Multi-Floor Cutter	44, 45						
10-963	Vinyl Seam Roller	41						
10-975	Power-Lok® Extendible Flooring Roller	40						

WORLD-CLASS MANUFACTURING



ROBERTS® WARRANTY

At **ROBERTS**, customer satisfaction is paramount, which is why we offer a best in class warranty program. In doing so most of our tools, underlayments, and accessories carry a limited-lifetime warranty, two-year warranty, or a one-year warranty. This warranty does not cover accidental damages, unreasonable or improper use, normal wear and tear, loss of use, or consequential damages. To ensure warranty eligibility, product registration (included with the product packaging) must be completed within 30 days of purchase. This warranty covers refund or replacement due to a defect in materials or workmanship.

Visit us online at robertsconsolidated.com for individual warranty terms and details; visit robertsconsolidated.com/warranty to register your product.

ABOUT CALIFORNIA PROPOSITION 65

Proposition 65 is a California regulatory law that requires businesses to notify California consumers about specific chemicals in the products they purchase so they can make informed decisions about protecting themselves from exposure to these chemicals. This law requires companies to properly label products that contain chemical(s) above certain threshold levels.

As part of Q.E.P. Co. Inc.'s continued best business practice and compliance program, we comply with Proposition 65 warning requirements and provide product-associated warnings. We are dedicated to meeting consumer product safety requirements applicable to our products and strive to provide high quality and safe products.

For more information on California Proposition 65, go to www.P65Warnings.ca.gov.

- *Prop 65 - 1. **⚠️WARNING:** This product can expose you to chemicals including DEHP, which is known to the State of California to cause cancer, birth defects and other reproductive harm.
- *Prop 65 - 2. **⚠️WARNING:** This product can expose you to chemicals including Lead, which is known to the State of California to cause cancer, birth defects and other reproductive harm.
- *Prop 65 - 3. **⚠️WARNING:** This product can expose you to chemicals including Nickel (Metallic), which is known to the State of California to cause cancer.
- *Prop 65 - 4. **⚠️WARNING:** This product can expose you to chemicals including Lead and DEHP which is known to the State of California to cause cancer, birth defects or other reproductive harm.
- *Prop 65 - 5. **⚠️WARNING:** This product can expose you to chemicals including Quartz and Styrene, which are known to the State of California to cause cancer and Methanol, which is known to the State of California to cause birth defects or other reproductive harm.
- *Prop 65 - 6. **⚠️WARNING:** This product can expose you to chemicals including Silicia (crystalline, respirable) and Diisodecyl Phthalates which are known to the state of California to cause cancer, and birth defects or other reproductive harm.

The products, specifications, and Prop 65 Warnings listed in this catalog are current as of the printed date of this catalog and are subject to change. Access product data sheets, technical bulletins, warranties and SDS documents 24 hours a day, 7 days a week through our continuously updated website.

TRADEMARKS

ROBERTS®, Black Jack Floating Floor Underlayment®, Cool Shield®, Double-Tap®, the e® logo, First Step®, GoldGuard®, Golden Touch®, Max Complete®, Max Grip®, Quiet Cushion®, Soft Stride®, Super Felt®, The General®, The Maverick®, Tiger Tooth®, and Unison® are registered trademarks of Roberts Consolidated Industries, Inc.

Falcon Power 44™ and PowerTak™ are trademarks of Roberts Consolidated Industries, Inc.

Aquabar® "B" is a registered trademark of Fortifiber, LLC.

Microban® is a registered trademark of Microban Products Company.

Rug Gripper™ is a trademark of Optimum Technologies, Inc.

CRI™ is a trademark of The Carpet and Rug Institute

2025 FLOORING TOOLS & UNDERLAYMENTS

Supporting Professional Installers Since 1938

Products on Front Cover:

10-56 Longneck Plus 6" Jamb Saw, 10-195 Heavy Duty Scraper, 10-975 Power Lok Extendible Floor Roller, 10-16 Carpet, Vinyl & Utility Knife, 10-43 Pro Floor Installation Kit, 10-284 Falcon Power 44 Stretcher and 10-942 13" PrecisionCuts™ Multi-Floor Cutter

Products on Back Cover:

Heavy-Duty 100 lbs. Flooring Roller (10-952) and Pro Comfort Knee Pads (79034)



1001 Broken Sound Parkway, NW
Boca Raton, Florida 33487

For more information call 866-435-8665
Se habla español | français parlé



robertsconsolidated.com



Scan here
for the latest



ROBERTS®
TOOL CATALOG

Scan here
for the latest



ROBERTS®
ADHESIVE CATALOG

Scan here
for the latest



ROBERTS®
ADHESIVE
PRODUCT GUIDE

D1124-12468
ROBT00L2025